



The Building Regulations 2000

Structure

A

APPROVED DOCUMENT

- A1** **Loading**
- A2** **Ground movement**
- A3** **Disproportionate collapse**

2004 EDITION

MAIN CHANGES IN THE 2004 EDITION

This edition of Approved Document A, Structure, replaces the 1992 Edition (with 1994 and 2000 amendments edition). The main changes are:

Use of Guidance

- a. **Eurocodes:** an announcement is given regarding the forthcoming introduction of the Structural Eurocodes and their National Annexes.
- b. **House construction:** reference is made to the intended publication of guidance by industry of alternative forms of house construction to that of traditional masonry.

A1 and A2

Traditional dwellings

- c. The guidance on the sizing of timber floors and roofs for traditional house construction has been removed as the Timber Tables are now published by TRADA. However, the TRADA Tables are referenced under Section 2B.
- d. A revised map of basic wind speeds in accordance with BS6399:Part 2 replaces the superseded map which was based on BS CP3 Chapter V.
- e. Stainless steel cavity wall ties have been specified to all houses regardless of their location.
- f. The guidance on masonry walls to dwellings has been extended to enable the rules to be applicable when using either the appropriate British Standards or the emerging BS EN CEN Standards.
- g. The guidance on concrete foundations to houses has been revised to align with the recommendations given in the British Standards and other authoritative guidance. Recommendations on minimum foundation depths have also been included to counter the impact of predicted climate changes.
- h. The guidance on the design and construction of domestic garages has been extensively updated to reflect modern practice.

A3

- i. **Disproportionate collapse:** the Application Limit to the Requirement (ie. the 5 storey limit) has been removed so as to bring all buildings under control of the A3 Requirement.

The modified guidance has been developed from commissioned research and consideration of the recommendations given in the forthcoming Eurocode EN1991-1-7 on Accidental Actions.

Contents

	PAGE		PAGE
Use of Guidance	3	Thickness of walls	13
Loading and Ground Movement	5	Conditions relating to the wall	16
The Requirements	5	Construction materials and workmanship	17
Guidance	6	Loading on walls	24
Introduction	6	End restraint	24
Section 1: Codes, Standards and other references for all building types	7	Openings, recesses, overhangs and chases	26
Loading	7	Lateral support by roofs and floors	27
Structural work of timber	7	Interruption of lateral support	30
Structural work of masonry	7	Small single storey non-residential buildings and annexes	30
Structural work of reinforced, pre-stressed or plain concrete	7	Section 2D: Proportions for masonry chimneys above the roof surface	34
Structural work of steel	7	Height to width relationship	34
Structural work of aluminium	7	Section 2E: Foundations of plain concrete	35
Foundations	7	Conditions relating to the ground	35
Ground Movement (Requirement A2(b))	8	Design provisions	35
Existing buildings	8	Minimum width of strip foundations	35
Section 2: Sizes of structural elements for certain residential buildings and other small buildings of traditional construction	9	Minimum depth of strip foundations	36
General	9	Section 3: Wall Cladding	37
Definitions	9	General	37
Section 2A: Basic requirements for stability	10	Technical Approach	37
Section 2B: Sizes of certain timber members in floors and roofs for dwellings. Areas at risk from House Longhorn Beetle	11	Loading	37
Sizing of members	11	Fixings	37
House Longhorn Beetle	11	Further Guidance	38
Section 2C: Thickness of walls in certain small buildings	12	Section 4: Roof Covering	39
Application	12	Materials	39
Wall types	12	Recovering of roofs	39
The use of this section	12	DISPROPORTIONATE COLLAPSE	40
Conditions relating to the building of which the wall form part	12	The Requirement	40
		Guidance	41
		Performance	41
		Introduction	41
		Section 5: Reducing the sensitivity of the building to disproportionate collapse in the event of an accident	42
		Alternative Approach	43

A CONTENTS

	PAGE		PAGE
DIAGRAMS		TABLES	
1. Size and proportion of residential buildings of not more than 3 storeys	13	1. Areas at risk from House Longhorn Beetle	11
2. Size and proportion of non-residential buildings and annexes	14	2. Wall types considered in this section	12
3. Determination of wall thickness	15	3. Minimum thickness of certain external walls, compartment walls, and separating walls	15
4. Parapet walls: height	16	4. Imposed loads	17
5. Maximum floor area enclosed by structural walls	17	5. Cavity wall ties	21
6. Map showing wind speeds in m/s	18	6. Compressive Strength of Masonry Units complying with BS EN 771-1 to 5	21
7. Maximum height of buildings	19	7. Normalised compressive strength of masonry unit of clay and calcium silicate blocks complying with BS EN 771-1 and 2	24
8. Measuring storey and wall heights	20	8. Value of factor 'x'	28
9. Compressive strength of masonry units	22	9. Lateral support for walls	28
10. Declared compressive strength of masonry units	23	10. Minimum width of strip foundations	36
11. Maximum span of floors	24	11. Building Classes	42
12. Differences in ground level	25		
13. Openings in a buttressing wall	26		
14. Buttressing	27		
15. Sizes of openings and recesses	28		
16. Lateral support by floors	29		
17. Lateral support at roof level	30		
18. Size and location of openings	31		
19. Wall thickness	32		
20. Horizontal and lateral restraint at roof level	33		
21. Proportions for masonry chimneys	34		
22. Elevation of stepped foundation	35		
23. Piers and chimneys	35		
24. Foundation dimensions	35		
25. Area at risk of collapse in the event of an accident	44		

Use of Guidance

THE APPROVED DOCUMENTS

This document is one of a series that has been approved by the First Secretary of State for the purpose of providing practical guidance with respect to the requirements of Schedule 1 to and Regulation 7 of the Building Regulations 2000 (SI 2000/2531) for England and Wales. SI 2000/2531 has been amended by the Building (Amendment) Regulations 2001 (SI 2001/3335), by the Building (Amendment) Regulations 2002 (SI 2002/440), by the Building (Amendment) (No. 2) Regulations 2002 (SI 2002/2871), by the Building (Amendment) Regulations 2003 (SI 2003/2692) and by the Building (Amendment) Regulations 2004 (SI 2004/1465).

At the back of this document is a list of all the documents that have been approved and issued by the Secretary of State for this purpose.

Approved Documents are intended to provide guidance for some of the more common building situations. However, there may well be alternative ways of achieving compliance with the requirements. **Thus there is no obligation to adopt any particular solution contained in an Approved Document if you prefer to meet the relevant requirement in some other way.**

Other requirements

The guidance contained in an Approved Document relates only to the particular requirements of the Regulations which that document addresses. The building work will also have to comply with the requirements of any other relevant paragraphs in Schedule 1 to the Regulations.

There are Approved Documents which give guidance on each of the parts of Schedule 1 and on regulation 7.

LIMITATION ON REQUIREMENTS

In accordance with regulation 8, the requirements in Parts A to K and N of Schedule 1 to the Building Regulations do not require anything to be done except for the purpose of securing reasonable standards of health and safety for persons in or about the buildings.

MATERIALS AND WORKMANSHIP

Any building work which is subject to requirements imposed by Schedule 1 to the Building Regulations should, in accordance with regulation 7, be carried out with proper materials and in a workmanlike manner.

You may show that you have complied with regulation 7 in a number of ways. These include the appropriate use of a product bearing CE marking in accordance with the

Construction Products Directive (89/106/EEC)¹ as amended by the CE Marking Directive (93/68/EEC)², or a product complying with an appropriate technical specification (as defined in those Directives), a British Standard, or an alternative national technical specification of any state which is a contracting party to the European Economic Area which, in use, is equivalent, or a product covered by a national or European certificate issued by a European Technical Approval Issuing body, and the conditions of use are in accordance with the terms of the certificate. You will find further guidance in the Approved Document supporting regulation 7 on materials and workmanship.

Independent certification schemes

There are many UK product certification schemes. Such schemes certify compliance with the requirements of a recognised document which is appropriate to the purpose for which the material is to be used. Materials which are not so certified may still conform to a relevant standard.

Many certification bodies which approve such schemes are accredited by UKAS.

Technical specifications

Building Regulations are made for specific purposes; health and safety, energy conservation and the welfare and convenience of disabled people. Standards and technical approvals are relevant guidance to the extent that they relate to these considerations. However, they may also address other aspects of performance such as serviceability, or aspects which although they relate to health and safety are not covered by the Regulations.

When an Approved Document makes reference to a named standard, the relevant version of the standard is the one listed at the end of the publication. However, if this version has been revised or updated by the issuing standards body, the new version may be used as a source of guidance provided it continues to address the relevant requirements of the Regulations.

The appropriate use of a product which complies with a European Technical Approval as defined in the Construction Products Directive will meet the relevant requirements.

¹ As implemented by the Construction Products Regulations 1991 (S.1. 1991/1620).

² As implemented by the Construction Products (Amendment) Regulations 1994 (S. 1. 1994/3051).

The Department intends to issue periodic amendments to its Approved Documents to reflect emerging harmonised European Standards. Where a national standard is to be replaced by a European harmonised Standard, there will be a co-existence period during which either standard may be referred to. At the end of the co-existence period the national standard will be withdrawn.

many Parts which, when used in conjunction with their National Annexes and when approved by the Secretary of State, are intended to be referenced in this Approved Document as practical guidance on meeting the Part A Requirements.

THE WORKPLACE (HEALTH, SAFETY AND WELFARE) REGULATIONS 1992

The Workplace (Health, Safety and Welfare) Regulations 1992 contain some requirements which affect building design. The main requirements are now covered by the Building Regulations, but for further information see: *Workplace health, safety and welfare, The Workplace (Health, Safety and Welfare) Regulations 1992, Approved Code of Practice and Guidance*; The Health and Safety Commission, L24; Published by HMSO 1992; ISBN 0-11-886333-9.

The Workplace (Health, Safety and Welfare) Regulations 1992 apply to the common parts of flats and similar buildings if people such as cleaners and caretakers are employed to work in these common parts. Where the requirements of the Building Regulations that are covered by this Part do not apply to dwellings, the provisions may still be required in the situations described above in order to satisfy the Workplace Regulations.

OTHER FORMS OF HOUSE CONSTRUCTION

This Approved Document includes guidance on structural elements of residential buildings of traditional masonry construction. It is recognised, however, that there are other suitable forms of construction in use in the housing sector some of which (e.g. timber framed) have been in common use for a number of years and have demonstrated an adequate performance in compliance with the A1 requirement. Such alternative forms include prefabricated timber, light steel and pre-cast concrete framed construction.

A number of guidance documents relating to these alternative forms are presently being developed by industry. The intention is to reference these in this Approved Document as soon as they become available and are approved by the Secretary of State.

EUROCODES

The British Standards Institution will shortly be publishing a series of Structural Eurocodes, together with their National Annexes. These Eurocodes are CEN Standards comprising

The Requirements

This Approved Document deals with the following Requirements which are contained in the Building Regulations 2000 (as amended by SI 2001/3335, SI 2002/440, SI 2002/2871 and SI 2003/2692.

<i>Requirement</i>	<i>Limits on application</i>
<p>Loading</p>	
<p>A1. (1) The building shall be constructed so that the combined dead, imposed and wind loads are sustained and transmitted by it to the ground -</p>	
<ul style="list-style-type: none"> (a) safely; and (b) without causing such deflection or deformation of any part of the building, or such movement of the ground, as will impair the stability of any part of another building. 	
<p>(2) In assessing whether a building complies with sub paragraph (1) regard shall be had to the imposed and wind loads to which it is likely to be subjected in the ordinary course of its use for the purpose for which it is intended.</p>	
<p>Ground Movement</p>	
<p>A2. The building shall be constructed so that ground movement caused by :-</p>	
<ul style="list-style-type: none"> (a) swelling, shrinkage or freezing of the subsoil; or (b) land-slip or subsidence (other than subsidence arising from shrinkage), in so far as the risk can be reasonably foreseen, will not impair the stability of any part of the building. 	

Guidance

Introduction

0.1 In the Secretary of State's view the requirements of A1 and A2 will be met by following the recommendations given in the documents listed in Section 1 or by adopting the guidance in Sections 2-4

- a. **Section 1** is relevant to all building types and lists Codes, Standards and other references for structural design and construction but, where they do not give precise guidance, consideration should be given to paragraph 0.2.
- b. **Section 2** give sizes of structural elements for certain residential buildings and other small buildings of traditional construction.
- c. **Section 3** gives guidance on the support and fixing of wall cladding
- d. **Section 4** gives guidance where roofs are to be re-covered as a material alteration as defined in the Regulations.

0.2 The safety of a structure depends on the successful combination of design and completed construction, particularly :

- a. The design should be based on identification of the hazards to which the structure is likely to be subjected and assessment of the risks. The selection of relevant critical situations for design should be made reflecting the conditions that can reasonably be foreseen during future use.
- b. Loading. Dead load, imposed load and wind load should be in accordance with the current Codes of Practice referred to in Section 1 of this document.
- c. Properties of materials
- d. Detailed design and assembly of the structure
- e. Safety factors
- f. Workmanship

The numeric values of safety factors, whether expressed explicitly or implicitly in design equations, or design values, should be derived from considerations of the above aspects of design and construction as a whole. A change in any one of these aspects may disturb the safety of structure.

Loads used in calculations should allow for possible dynamic, concentrated and peak load effects that may occur.

0.3 Grandstands and structures erected in places of public assembly may need to sustain the synchronous or rhythmic movement of numbers of people. It is important to ensure that the design of the structure takes these factors into account so as to avoid the

structure being impaired or causing alarm to people using the structure.

Interim guidance on the design of grandstands may be found in "Dynamic performance requirements for permanent grandstands subject to crowd action, Interim Guidance on assessment and design" published by the Institution of Structural Engineers, November 2001.

Supplementary advice on the dynamic testing of grandstands and seating decking has been published in an Advisory Note by the Institution of Structural Engineers June 2002.

Section 1: Codes, Standards and References for all Building types

Introduction

1.1 This section is relevant to all building types and lists codes, standards and other references for structural design and construction.

References

1.2 Loading:

a. Dead and imposed loads

BS 6399 : Loading for buildings :

Part 1 : 1996 Code of practice for dead and imposed loads.

b. Wind Loads

BS 6399 : Loading for buildings:

Part 2 : 1997 Code of practice for wind loads
BRE Digest 436 : Parts 1, 2 and 3 (Brief guidance for using BS 6399 : Part 2).

c. Imposed roof loads

BS 6399 : Loading for buildings:

Part 3 : 1988 Code of practice for imposed roof loads.

1.3 Structural work of timber:

BS 5268 : Structural use of timber :

Part 2 : 2002 Code of practice for permissible stress design, materials and workmanship.

Part 3 : 1998 Code of practice for trussed rafter roofs.

BS 8103 : Structural design of low-rise buildings.

Part 3 : 1996 Code of practice for timber floors and roofs for housing.

1.4 Structural work of masonry:

BS 5628 : Code of practice for use of masonry:

Part 1 : 1992 Structural use of unreinforced masonry.

Part 2 : 2000 Structural use of reinforced and prestressed masonry.

Part 3 : 2001 Materials and components, design and workmanship.

BS 8103 : Structural design of low-rise buildings:

Part 1 : 1995 Code of practice for stability, site investigation, foundations and ground floor slabs for housing.

Part 2 : 1996 Code of practice for masonry walls for housing.

1.5 Structural work of reinforced, pre-stressed or plain concrete:

BS 8110 : Structural use of concrete:

Part 1 : 1997 Code of practice for design and construction.

Part 2 : 1985 Code of practice for special circumstances.

Part 3 : 1995 Design charts for singly reinforced beams, doubly reinforced beams and rectangular columns.

BS 8103 : Structural design of low rise buildings: Part 4 : 1995 Code of practice for suspended concrete floors for housing.

1.6 Structural work of steel:

BS 5950 : Structural use of steelwork in Building:

Part 1 : 2000 Code of practice for design in simple and continuous construction : hot rolled and welded sections.

Part 2 : 2001 Specification for materials, fabrication and erection, hot rolled sections.

Part 3 : Design in composite construction : Section 3.1 : 1990 Code of practice for design of simple and continuous composite beams.

Part 4 : 1994 Code of practice for design of composite slabs with profiled steel sheeting.

Part 5 : 1998 Code of practice for design of cold formed thin gauge sections.

BRE Digest 437 - Industrial platform floors : mezzanine and raised storage.

1.7 Structural work of aluminium:

BS 8118 : Structural use of aluminium:

Part 1 : 1991 Code of practice for design.

Part 2 : 1991 Specification for materials, workmanship and protection.

1.8 Foundations:

BS 8002 : 1994 Code of practice for earth retaining structures.

BS 8004 : 1986 Code of practice for foundations.

Ground Movement (Requirement A2b.)

1.9 There may be known or recorded conditions of ground instability, such as that arising from landslides, disused mines or unstable strata which, if ignored, can have a devastating effect on the safety of a building and its environs. Such conditions should be taken into account in the design of the building and its foundations. Attention is drawn to DOE Planning Policy Guidance Note 14 Development on unstable land (obtainable from the Stationary office), which sets out the broad planning and technical issues relating to development on unstable land.

The Department has also sponsored a series of reviews aimed at determining the scale and nature of problems arising from mining instability, natural underground cavities and adverse foundation conditions. Databases of both subsidence incidents and subsidence potential produced from these reviews are available from the following licence holders :

British Geological Survey, Sir Kingsley Dunham Centre, Keyworth, Nottingham NG12 5GG.

Landmark, 7 Abbey Court, Eagle Way, Exeter, Devon EX2 7HY,

Peter Brett Associates, 16 Westcote Road, Reading, Berkshire RG20 2DE.

Catalytic Data Ltd., The Spinney, 19 Woodlands Road, Bickley, Kent BRI 2AD

The reports from these reviews, which include 1:250,000 scale maps showing the distribution of the physical constraints, are available from the following organisations :

Arup Geotechnics, 1991. Review of mining instability in Great Britain.

Obtainable from Arup Geotechnics, Bede House, All Saints, Newcastle-upon-Tyne NE1 2EB.

Applied Geology Ltd., 1994. Review of instability due to natural underground cavities in Great Britain.

Obtainable from Kennedy & Donkin Ltd., 14 Calthorpe Road, Edgbaston, Birmingham B15 1TH.

Wimpey Environmental Ltd., and National House Building Council, 1995. Foundation conditions in Great Britain, a guide for planners and developers. Obtainable from ESNR International Ltd., 16 Frogmore Road, Hemel Hempstead, Hertfordshire HP3 9RW.

Existing buildings

1.10 Compliance with Part A (Structure) is required in certain classes of change of use of a building, subject to the control of Regulations 5 and 6. Guidance relevant to structural

appraisals related to 'change of use' is given in the following documents :

- a. BRE Digest 366 : Structural Appraisal of Existing Buildings for Change of Use.
- b. The Institution of Structural Engineers Report Appraisal of Existing Structures, 1996.

Note: With reference to the item 'design checks' in the above mentioned Institution of Structural Engineers report the choice of various partial factors should be made to suit the individual circumstances of each case.

Section 2: Sizes of Structural Elements for certain residential buildings and other small buildings of Traditional Construction

General

2.1 This Section is presented as follows:

Section 2A

Basic requirements for stability.

Section 2B

Sizes of certain timber members in floors and roofs for dwellings.

Areas at risk from house longhorn beetle.

Section 2C

Thickness of masonry walls in certain residential buildings of not more than 3 storeys, small single storey non-residential buildings and annexes.

Section 2D

Proportions for masonry chimneys.

Section 2E

Foundations of plain concrete.

2.2 Section 2A gives general rules which must be observed in following Sections 2B and 2C. Sections 2B to 2E may be used independently of each other.

Throughout this section the diagrams are only illustrative and do not show all the details of construction.

Definitions

2.3 The following meanings apply to terms throughout this Section:

Buttressing wall A wall designed and constructed to afford lateral support to another wall perpendicular to it, support being provided from the base to the top of the wall.

Cavity width The horizontal distance between the two leaves of a cavity wall.

Compartment wall A wall constructed as a compartment wall to meet the requirements of regulation B3(2).

Dead load The load due to the weight of all walls, permanent partitions, floors, roofs and finishes including services, and all other permanent construction.

Imposed load The load assumed to be produced by the intended occupancy or use, including the weight of movable partitions, distributed, concentrated, impact, inertia and snow loads, but excluding wind loads.

Pier A member which forms an integral part of a wall, in the form of a thickened section at intervals along the wall, so as to afford lateral support to the wall to which it is bonded or securely tied.

Separating wall A wall or part of a wall which is common to adjoining buildings, and constructed to meet the requirements of regulation B3(2).

Spacing The distance between the longitudinal centres of any two adjacent timber members of the same type, measured in the plane of floor, ceiling or roof structure.

Span The distance measured along the centre line of a member between the centres of any two adjacent bearings or supports.

Supported Wall A wall to which lateral support is afforded by a combination of buttressing walls piers or chimneys acting in conjunction with floor(s) or roof.

Wind load The load due to the effect of wind pressure or suction.

Section 2A: Basic Requirements for Stability

2A1 This section must be used in conjunction with sections 2B and 2C and its principles relate to all forms of low rise residential buildings.

2A2 Adequate provision shall be made to ensure that the building is stable under the likely imposed and wind loading conditions. This will commonly necessitate meeting the following requirements:

- a. That the overall size and proportioning of the building are limited in accordance with the specific guidance for each form of construction.
- b. That a suitable layout of walls (both internal and external) forming a robust 3 dimensional box structure in plan is constructed with restriction on the maximum size of cells measured in accordance with the specific guidance for each form of construction.
- c. That the internal and external walls are adequately connected by either masonry bonding or by using mechanical connections.
- d. That the intermediate floors and roof are of such construction and interconnection with the walls that they provide local support to the walls and also act as horizontal diaphragms capable of transferring the wind forces to buttressing elements of the building.

Note: A traditional cut timber roof (i.e. using rafters, purlins and ceiling joists) generally has sufficient built in resistance to instability and wind forces (eg from either hipped ends, tiling battens, rigid sarking, or the like). However, the need for diagonal rafter bracing equivalent to that recommended in BS 5268: Part 3: 1998 or Annex H of BS 8103: Part 3: 1996 for trussed rafter roofs, should be considered especially for single-hipped and non-hipped roofs of greater than 40° pitch to detached houses.

Section 2B: Sizes of certain timber members in floors and roofs for dwellings. Areas at risk from House Longhorn Beetle

Sizing of Members

2B1 Guidance on the sizing of certain members in floors and roofs is given in “Span tables for solid timber members in floors, ceilings and roofs (excluding trussed rafter roofs) for dwellings”, published by TRADA, available from Chiltern House, Stocking Lane, Hughenden Valley, High Wycombe, HP14 4ND, Bucks.

Alternative guidance is available in BS 5268: Part 2: 2002 Code of Practice for permissible stress design, materials and workmanship, BS 5268: Part 3: 1998, Code of Practice for trussed rafter roofs and BS 8103: Part 3: Structural design of low-rise buildings, Code of Practice for timber floors and roofs for dwellings.

House Longhorn Beetle

2B2 In the geographical areas specified in Table 1, softwood timber for roof construction or fixed in the roof space, including ceiling joists within the void spaces of the roof, should be adequately treated to prevent infestation by the House Longhorn Beetle (*Hylotrupes bajulus* L).

Guidance on suitable preservative treatments is given within the British Wood Preserving and Damp-Proofing Associations Manual (2000 revision), available from 1 Gleneagles House, Vernongate, South Street, Derby DE1 1UP.

Table 1 Areas at risk from House Longhorn Beetle

Geographical Area

In the Borough of Bracknell Forest the parishes of Sandhurst and Crowthorne.

The Borough of Elmbridge

In the District of Hart, the parishes of Hawley and Yateley

The District of Runnymede

The Borough of Spelthorne

The Borough of Surrey Heath

In the Borough of Rushmoor, the area of the former district of Farnborough The Borough of Woking

Section 2C: Thickness of walls in certain small buildings

Application

2C1 This Section applies to the following building types:

- a. residential buildings of not more than three storeys, and
- b. small single storey non-residential buildings, and
- c. small buildings forming annexes to residential buildings. (including garages and outbuildings).

Wall types

2C2 Only the types of wall given in Table 2, which must extend to the full storey height, and parapet walls are considered in this section.

The use of this Section

2C3 When using this Section it should be noted that:

- a. this section must be used in conjunction with Section 2A;
- b. if wall thickness is to be determined according to paragraphs **2C5** to **2C13**, all appropriate design conditions given in this section must be satisfied;
- c. walls should comply with the relevant requirements of BS 5628: Part 3:2001, except as regards the conditions given in paragraphs **2C4** and **2C14** to **2C38**.
- d. in formulating the guidance of this section the worst combination of circumstances likely to arise was taken into account. If a requirement of this part is considered too onerous in a particular case it may be appropriate to consider a minor departure on the basis of judgement and experience, or to show adequacy by calculation in respect of the aspect of the wall

which is subject to the departure rather than for the entire wall;

- e. the guidance given is based upon the compressive strengths of bricks and blocks being not less than indicated in Tables 6 and 7.

BS 5628 Part 1: 1992 gives design strengths for walls where the suitability for use of masonry units of other compressive strengths is being considered.

Conditions relating to the building of which the wall forms part

2C4 This Section applies only to buildings having proportions within the following parameters (see Diagrams 1 and 2)

- a. **residential buildings of not more than 3 storeys:**
 - i. the maximum height of the building measured from the lowest finished ground level adjoining the building to the highest point of any wall or roof should not be greater than 15m, subject to the limits of paragraph **2C16**,
 - ii. the height of the building H should not exceed twice the least width of the building W1,
 - iii. the height of the wing H2 should not exceed twice the least width of the wing W2 where the projection P exceeds twice the width W2.
- b. **small single-storey non-residential buildings:** height H should not exceed 3m and W (being the greatest length or width of the building) should not exceed 9m (see Diagram 2), subject to the limits of paragraph **2C16**.

Table 2 Wall types considered in this Section

Residential buildings of up to three storeys
external walls
internal load bearing walls
compartment walls
separating walls
Small single storey non-residential buildings and annexes
external walls
internal load bearing walls

Diagram 1 Size and proportion of residential buildings of not more than 3 storeys

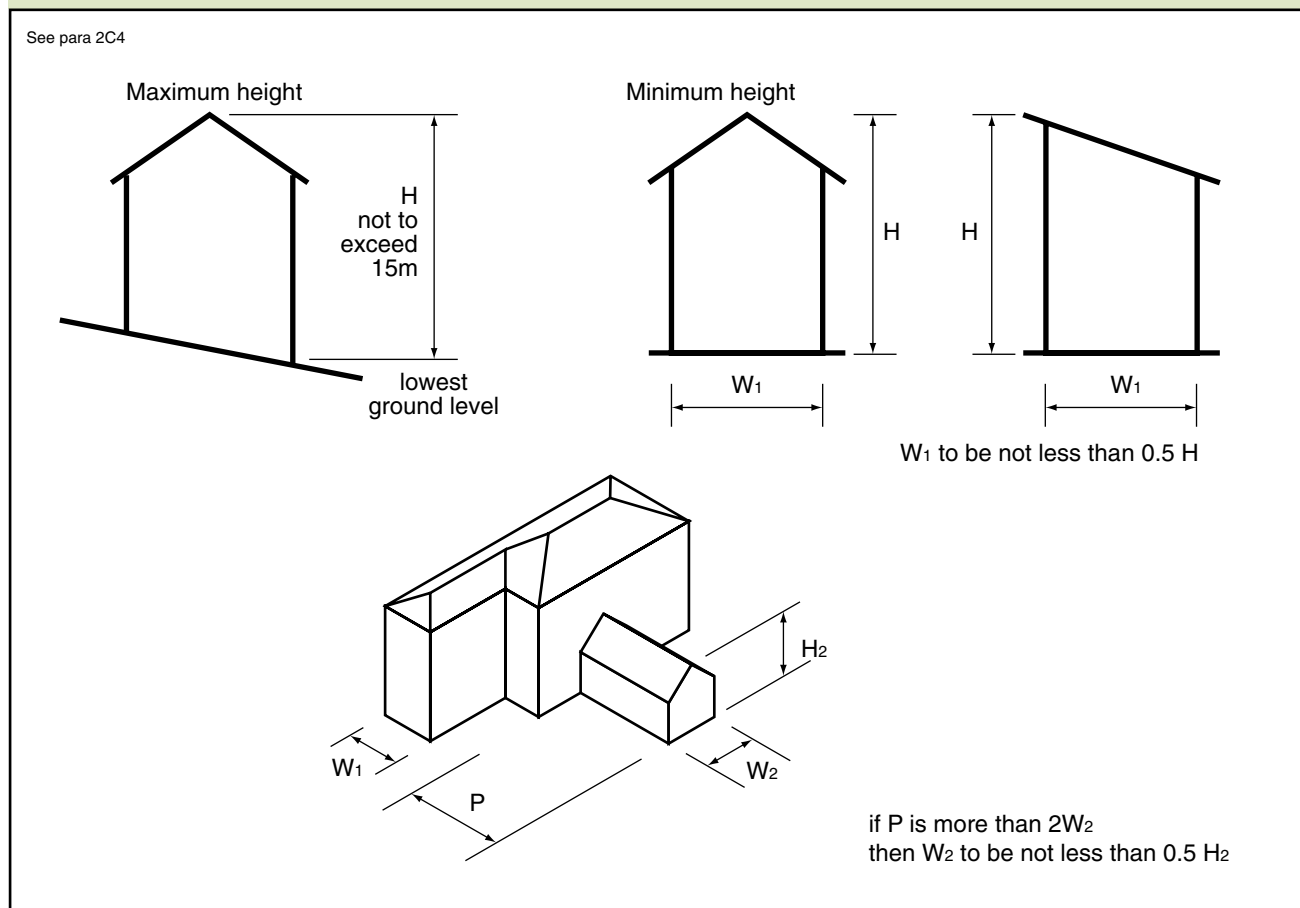

c. **annexes:** height H as variously indicated in Diagram 2 should not exceed 3m, subject to the limits of paragraph 2C16.

Thickness of walls

2C5 General wall thickness may be determined according to this Section provided:

a. condition relating to the building of which the wall forms part (see paragraphs 2C4, 2C14 to 2C16, 2C38) and

b. condition relating to the wall (see paragraphs 2C17 to 2C37) are met. (See diagram 3)

2C6 Solid external walls, compartment walls and separating walls in coursed brickwork or blockwork: Solid walls constructed of coursed brickwork or blockwork should be at least as thick as 1/16 of the storey height. Further requirements are given in Table 3.

2C7 Solid external walls, compartment walls and separating walls in uncoursed stone, flints etc.: The thickness of walls constructed in uncoursed stone, flints, clunches, of bricks or other burnt or vitrified material should not be less than 1.33 times the thickness determined by paragraph 2C6.

2C8 Cavity walls in coursed brickwork or blockwork: All cavity walls should have leaves at least 90mm thick and cavities at least 50mm

wide. The wall ties should have a horizontal spacing of 900mm and a vertical spacing of 450mm, which is equivalent to 2.5 ties per square metre. Wall ties should also be provided, spaced not more than 300mm apart vertically, within a distance of 225mm from the vertical edges of all openings, movement joints and roof verges. For selection of wall ties for use in a range of cavity widths refer to Table 5. For specification of cavity wall ties refer to paragraph 2C19.

For external walls, compartment walls and separating walls in cavity construction, the combined thickness of the two leaves plus 10mm should not be less than the thickness determined by paragraph 2C6 and Table 3 for a solid wall of the same height and length.

2C9 Walls providing vertical support to other walls: Irrespective of the material used in the construction, a wall should not be less in thickness than any part of the wall to which it gives vertical support.

2C10 Internal loadbearing walls in brickwork or blockwork: (except compartment walls or separating walls) should have a thickness not less than:

(specified thickness from Table 3) -5mm

2

Continued on page 16

Diagram 2 Size and proportion of non-residential buildings and annexes

See para 2C4b and 2C4c

a. Non-Residential Buildings

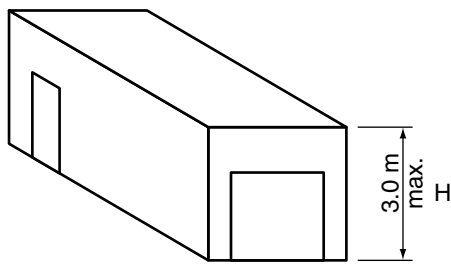

Flat roof buildings

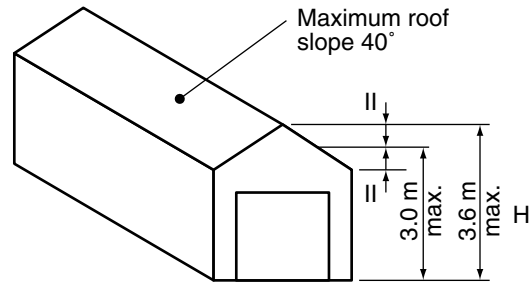

Pitched roof buildings

b. Annexes

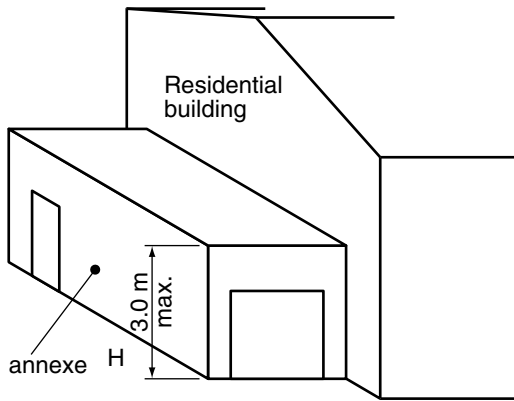

Flat roof annexes

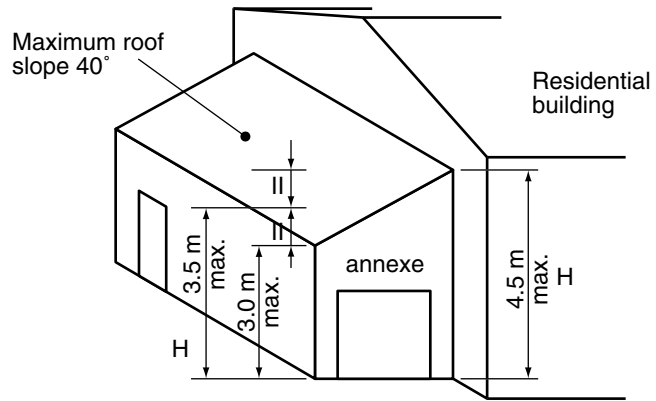

Pitched roof annexes (type 1)

Note
Height H should be measured from top of the foundation or from the underside of the floor slab where this provides effective lateral restraint.

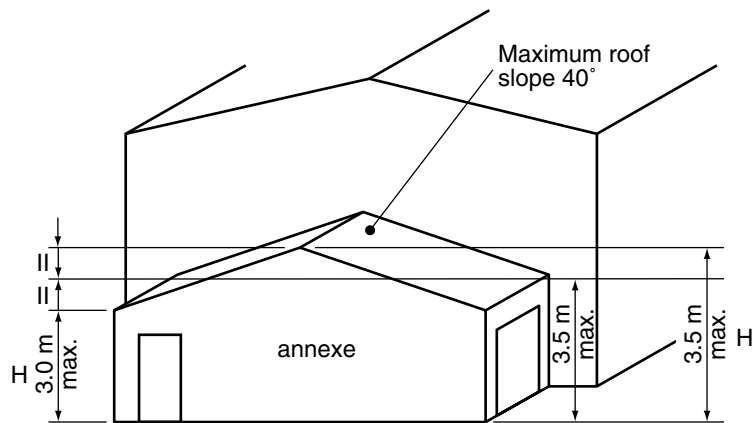

Pitched roof annexes (type 2)

Diagram 3 Determination of wall thickness

See para 2C5

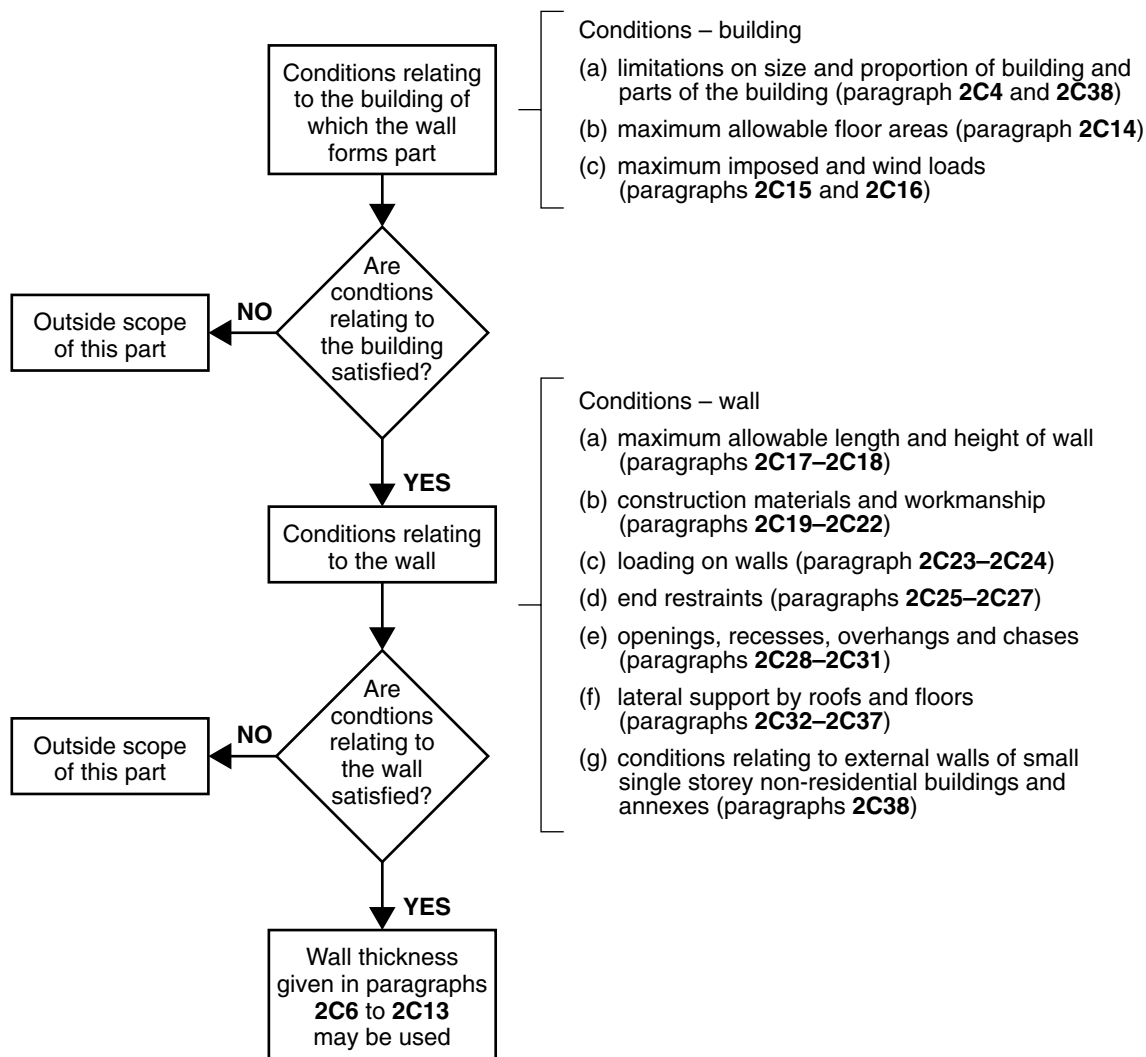
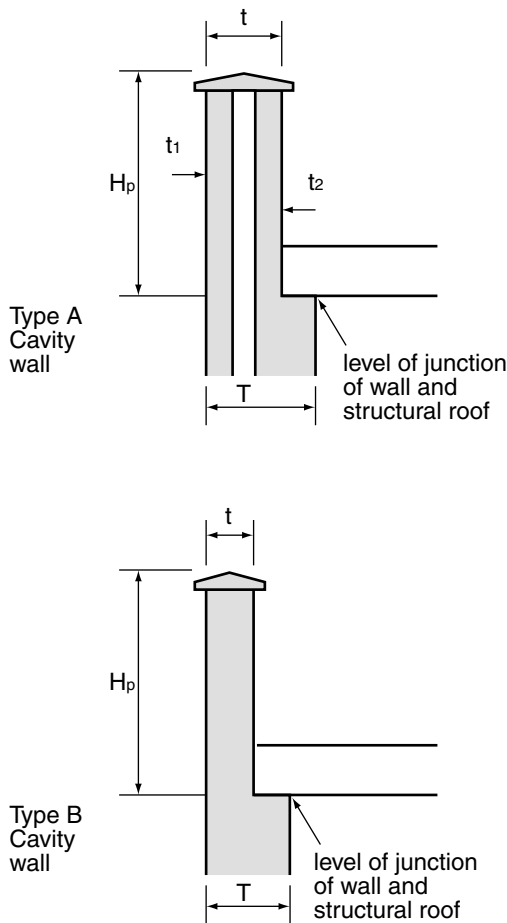

Table 3 Minimum thickness of certain external walls, compartment walls and separating walls

Height of wall	Length of wall	Minimum thickness of wall
not exceeding 3.5m	not exceeding 12m	190mm for whole of its height
exceeding 3.5m but not exceeding 9m	not exceeding 9m	190mm for whole of its height
	exceeding 9m	290mm from the based for the height of one storey and 190mm for the rest of its height
exceeding 9m but not exceeding 12m	not exceeding 9m	290mm from the based for the height of one storey and 190mm for the rest of its height
	exceeding 9m but not exceeding 12m	290mm from the base for the height of two storeys and 190mm for the rest of its height

Diagram 4 Parapet walls: height

See para 2C11



Wall type	Thickness (mm)	Parapet height H_p to be not more than (mm)
Type A Cavity wall	$t_1 + t_2$ equal or less than 200	600
	$t_1 + t_2$ greater than 200 equal or less than 250	860
Type B Cavity wall	$t = 150$	600
	$t = 190$	760
	$t = 215$	860

Note: t should be less than or equal to T

except for a wall in the lowest storey of a three storey building, carrying load from both upper storeys, which should have a thickness as determined by the equation or 140mm whichever is the greatest.

2C11 Parapet walls: The minimum thickness and maximum height of parapet walls should be as given in Diagram 4.

2C12 Single leaves of certain external walls: The single leaf of external walls of small single storey non-residential buildings and of annexes need be only 90mm thick, notwithstanding paragraphs 2C38

2C13 Modular bricks and blocks: Where walls are constructed of bricks or blocks having modular dimensions derived from BS6649 - 1985, wall thicknesses prescribed in this section which derive from a dimension of brick or block may be reduced by an amount not exceeding the deviation from work size permitted by a British Standard relating to equivalent sized bricks or blocks made of the same material.

2C14 Maximum floor area: The guidance of this Section assumes that no floor enclosed by structural walls on all sides exceeds 70m²; and that no floor without a structural wall on one side exceeds 36m². (See Diagram 5)

2C15 Imposed loads on roofs, floors and ceilings: The design considerations given in this Section are intended to be adequate for the imposed loads given in Table 4.

2C16 Maximum height of buildings: The design guidance in this section is based on BS 6399 : Part 2 : 1997. The maximum heights of buildings given in Table c of Diagram 7 correlate to various site exposure conditions and wind speeds. A map showing wind speeds is given in Figure 1 of Diagram 6.

Conditions relating to the wall

2C17 Maximum allowable length and height of the wall: This Section does not deal with walls longer than 12m, measured from centre to centre of buttressing walls, piers or chimneys providing restraint, or with walls exceeding 12m in height. (see also Table 3).

Diagram 5 Maximum floor area enclosed by structural walls

See para 2C14

a. Structural walls on all sides

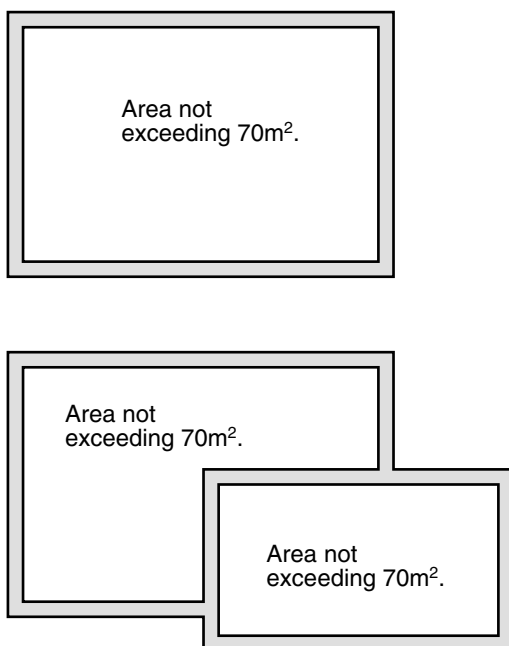

b. Structural walls on three sides

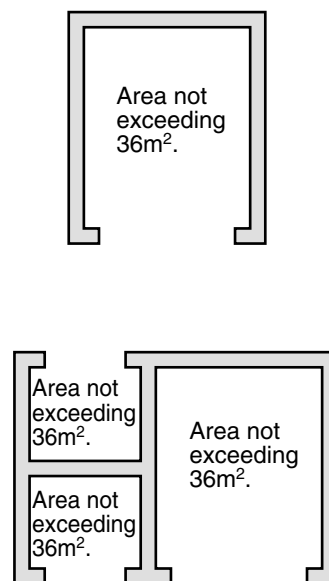

Table 4 Imposed Loads

Element	Loading
roof	distributed loads 1.00 kN/m ² for spans not exceeding 12m 1.5 kN/m ² for spans not exceeding 6m
floors	distributed load: 2.00kN/m ²
ceilings	distributed load: 0.25kN/m ² together with concentrated load: 0.9kN

2C18 Rules of measurement for heights of walls and storeys: The height of a wall or a storey should be measured in accordance with the rules in Diagram 8.

Construction materials and workmanship

2C19 Wall ties: Wall ties should either comply with BS 1243, DD 140, or BS EN 845-1 and should be material references 1 or 3 in BS EN 845 Table A 1 austenitic stainless steel. Wall ties should be selected in accordance with Table 5 of this A. D.

2C20 Masonry Units: Walls should be properly bonded and solidly put together with mortar and constructed of masonry units conforming to:-

a. clay bricks or blocks conforming to BS 3921: 1985 or BS 6649: 1985 or BS EN 771-1

b. calcium silicate bricks conforming to BS 187: 1978 or BS 6649: 1985 or BS EN 771-2

c. concrete bricks or blocks conforming to BS 6073: Part 1: 1981 or BS EN 771-3 or 4

d. square dressed natural stone conforming to the appropriate requirements described in BS EN 771-6 or BS 5628: Part 3: 2001

e. Manufactured stone complying with BS 6457: 1984 and BS EN 771-5

2C21 Compressive strength of masonry units: Minimum compressive strength requirements for masonry units according to BS Standards and BS EN Standards are given in Diagrams 9 and 10 respectively.

With reference to Diagram 9, the compressive strengths given for bricks and blocks are those values in accordance with the appropriate British Standards ie. BS 3921, BS 6073-1, BS 187, BS 5390 and BS 6649.

With reference to Diagram 10, the masonry units indicated for Conditions A, B and C should have declared compressive strengths of not less than the values given in Table 6. Normalised compressive strengths for block sized clay and calcium silicate masonry units not complying with brick dimensional format are given in Table 7.

Continued on page 24

Diagram 6 Map showing wind speeds in m/s for maximum height of buildings

See para 2C16

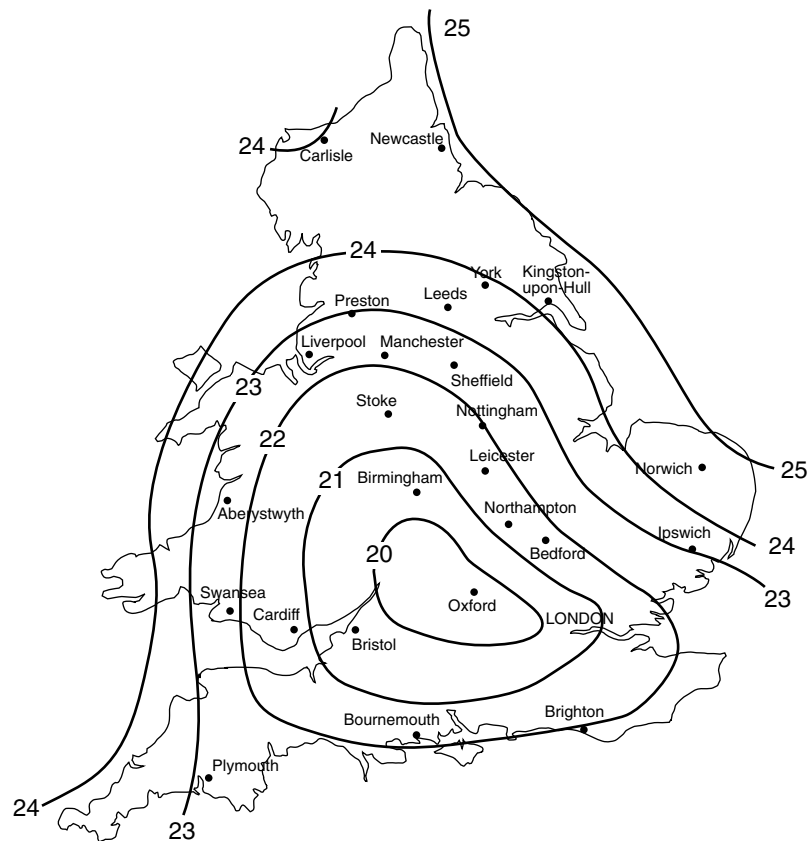

Figure 1 Map of wind speeds in m/s

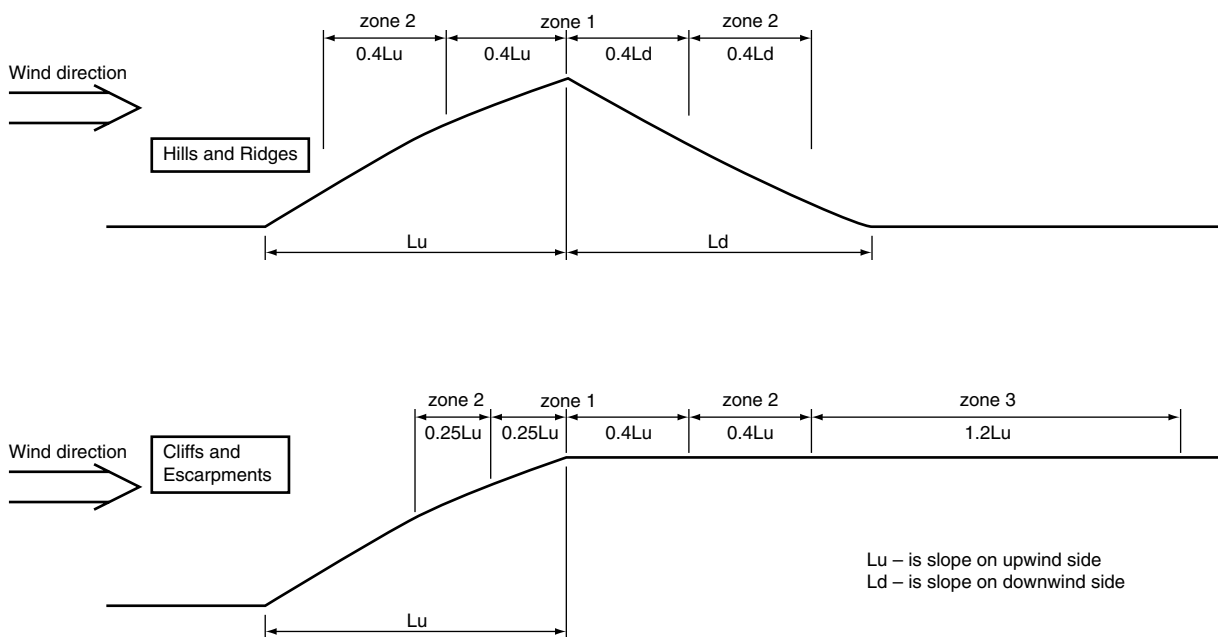
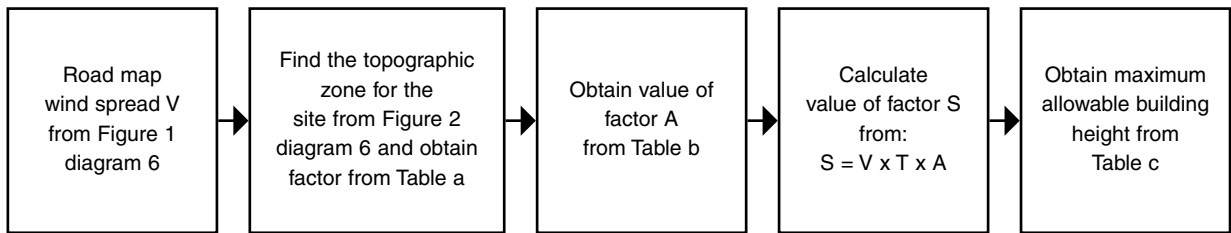

Figure 2 Topographic zones for Factor T

Diagram 7 Maximum height of buildings

See para 2C16



Topographic category and average slope of whole hillside, ridge, cliff or escarpment	Factor T		
	Zone 1	Zone 2	Zone 3
Category 1 : Nominally flat terrain, average slope < 1/20	1.0	1.0	1.0
Category 2 : Moderately steep terrain, average slope < 1/5	1.24	1.13	1.10
Category 3 : Steep terrain, average slope > 1/5	1.36	1.20	1.15

Note: Outside these zones factor T = 10

Site Altitude (m)	Factor A
0	1.00
50	1.05
100	1.10
150	1.15
200	1.20
300	1.30
400	1.40

Factor S	Country Sites			Town Sites*		
	Distance to the coast			Distance to the coast		
	< 10km	10-50km	> 50km	< 10km	10-50km	> 50km
24	15	15	15	15	15	15
25	11.5	14.5	15	15	15	15
26	8	10.5	13	15	15	15
27	6	8.5	10	15	15	15
28	4.5	6.5	8	13.5	15	15
29	3.5	5	6	11	13	14.5
30	3	4	5	9	11	12.5
31		3.5	4	8	9.5	10.5
32		3	3.5	7	8.5	9.5
33			3	6	7.5	8.5
34				5	7	8
35				4	6	7
36				3	5.5	6
37					4.5	5.5
38					4	5
39					3	4
40						3

* For sites on the outskirts of towns not sheltered by other buildings use the values for Country sites

Diagram 8 Measuring storey and wall heights

See para 2C18

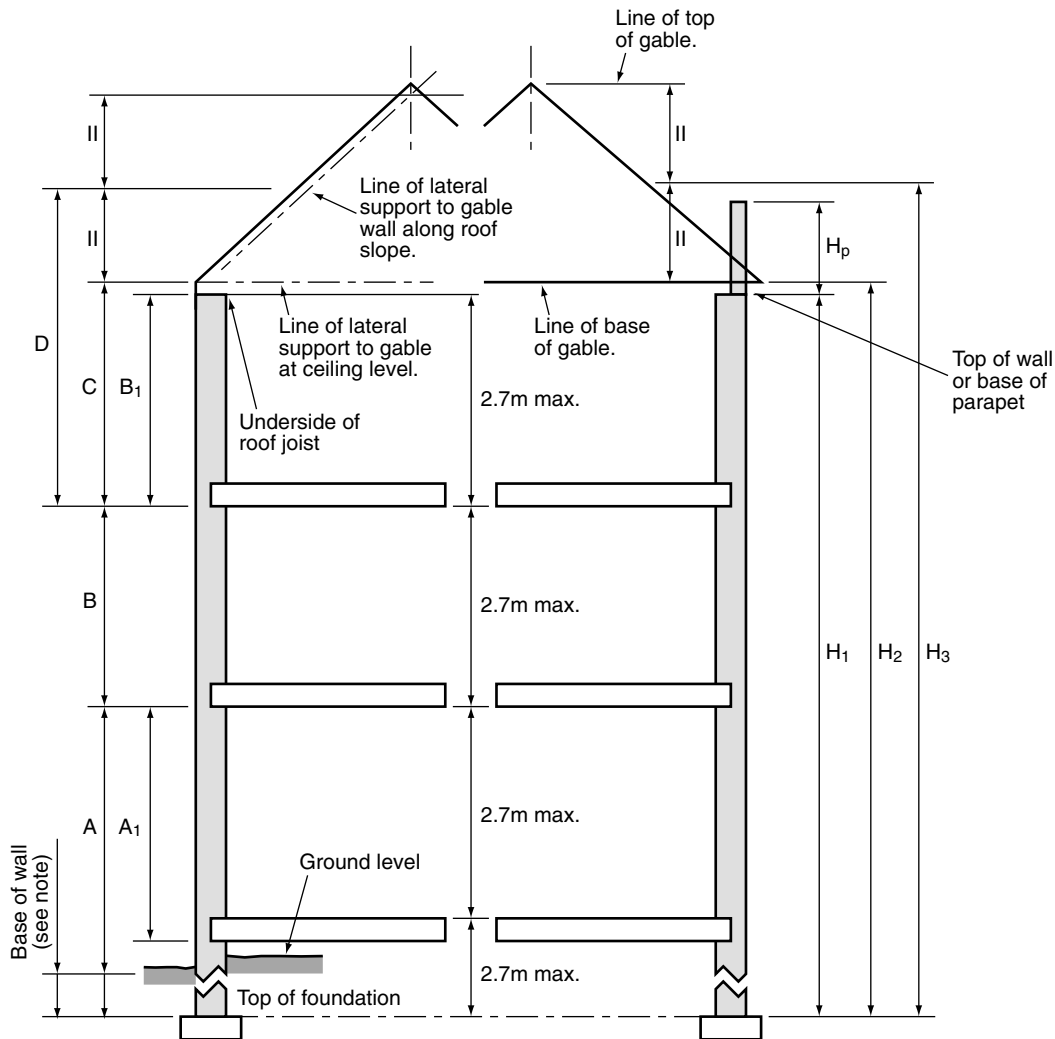

Key

(a) Measuring Storey Heights

A₁ is the ground storey height if the ground floor provides effective lateral support to the wall i.e. is adequately tied to the wall or is a suspended floor bearing on the wall.

A is the ground storey height if the ground floor does not provide effective lateral support to the wall.

Note: If the wall is supported adequately and permanently on both sides by suitable compact material, the base of the wall for the purposes of the storey height may be taken as the lower level of this support. (Not greater than 3.7m ground storey height.)

B is the intermediate storey height.

B₁ is the top storey height for wall which do not include a gable.

C is the top storey height where lateral support is given to the gable at both ceiling level and along the roof slope.

D is the topstorey height for the external walls which include a gable where lateral support is given to the gable only along the roof slope.

(b) Measuring Wall Heights

H₁ is the height of an external wall that does not include a gable.

H₂ is the height of an internal or separating wall which is built up to the underside of the roof.

H₃ is the height of an external wall which includes a gable.

H_p is the height of a parapet (see Diagram 4). If H_p is more than 1.2m add to H_p to H₁.

Table 5 Cavity wall ties

Normal cavity width mm (Note 1)	Permissible type of tie		
	Tie length mm (Note 2)	Tie Shape in accordance with BS 1243*	BS EN 845-1 tie (Note 4)
50 to 75	200	Butterfly, double triangle or vertical twist	Types 1, 2, 3 or 4 to DD 140-2* and selected on the basis of the design loading and design cavity width.
76 to 90	225	Double triangle or vertical twist	
91 to 100	225	Double triangle (Note 3) or vertical twist	
101 to 125	250	Vertical twist	
126 to 150	275	Vertical twist	*Although BS1243 and DD 140-2 are due to be withdrawn on 1 February 2005, the tie user classes (types) given in Tables 1 and 3 of the latter document can continue to be used after this date.
151 to 175	300	Vertical twist	
176 to 300	(See Note 2)	Vertical twist style	

Notes

- Where face insulated blocks are used the cavity width should be measured from the face of the masonry unit.
- The embedment depth of the tie should not be less than 50mm in both leaves. For cavities wider than 180mm calculate the length as the structural cavity width plus 125mm and select the nearest stock length.
- Double triangle ties of this shape having a strength to satisfy Type 2 of DD 140-2*, are manufactured. Specialist tie manufacturers should be consulted if 225mm long double triangle format ties are needed for 91 to 100mm cavities.
- Where BS EN 845-1 ties are used reference needs to be additionally made to DD 140-2* for the selection of the type (ie. types 1, 2, 3 or 4) relevant to the performance levels given in DD140-2.

Table 6 Declared Compressive Strength of Masonry Units complying with BS EN 771 - 1 to 5 (N/mm²)

Masonry Unit	Clay masonry units to BS EN 771-1		Calcium Silicate masonry units to BS EN 771-2		Aggregate Concrete Masonry Units to BS EN 771-3	Autoclaved aerated conc. Masonry units to BS EN 771-4	Manufactured Stone Masonry units to BS EN 771-5	
Condition A (See diagram 10)								
Brick	Group 1 6.0	Group 2 9.0	Group 1 6.0	Group 2 9.0	6.0	-	Any unit complying with BS EN 771-5 will be acceptable for conditions A, B and C	
Block	See Table 7	See Table 7	See Table 7	See Table 7	3.1*	3.1		
Condition B (See diagram 10)								
Brick	Group 1 9.0	Group 2 13.0	Group 1 9.0	Group 2 13.0	9.0	-		
Block	See Table 7	See Table 7	See Table 7	See Table 7	7.7*	7.7		
Condition C (See diagram 10)								
Brick	Group 1 18.0	Group 2 25.0	Group 1 18.0	Group 2 25.0	18.0	-		
Block	See Table 7	See Table 7	See Table 7	See Table 7	7.7*	7.7		

*These values are dry ground strengths to BS EN 772-1

Notes

- This table applies to Group 1 and Group 2 units.
- For the EN 771 series of standards for masonry units the values of declared compressive strengths (N/mm²) given in Table 6 are mean values.
- Brick: a masonry unit having work sizes not exceeding 337.5 mm in length or 112.5 mm in height.
- Block: a masonry unit exceeding either of the limiting work sizes of a brick and with a minimum bed height of 190mm. For blocks with smaller bed heights, excluding cuts or make up units, the strength requirements are as for brick except for solid external walls where the blocks should have a compressive strength at least equal to that shown for block for an inner leaf of a cavity wall in the same position.
- Group 1 masonry units have not more than 25% formed voids (20% for frogged bricks). Group 2 masonry units have formed voids greater than 25%, but not more than 55%.

Diagram 9 Compressive strength of masonry units

See para 2C21

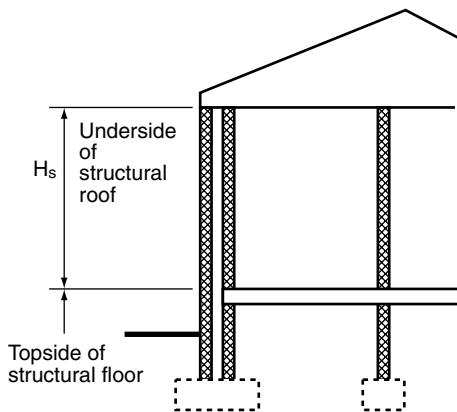

a. One Storey

Key

	Brick 5N/mm ²		Block 2.8N/mm ²
	Brick 7N/mm ²		Block 7N/mm ²
	Brick 15N/mm ²		Block 7N/mm ²
	Where H _f Less than or equal to 1m – Brick 5N/mm ² Block 2.8N/mm ²		
	Where H _f Greater than 1m – Brick 7N/mm ² Block 7N/mm ²		

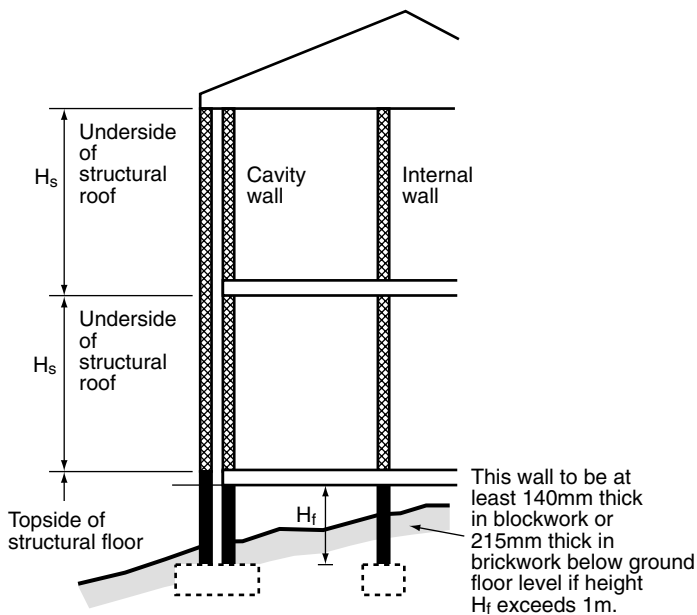

b. Two Storeys

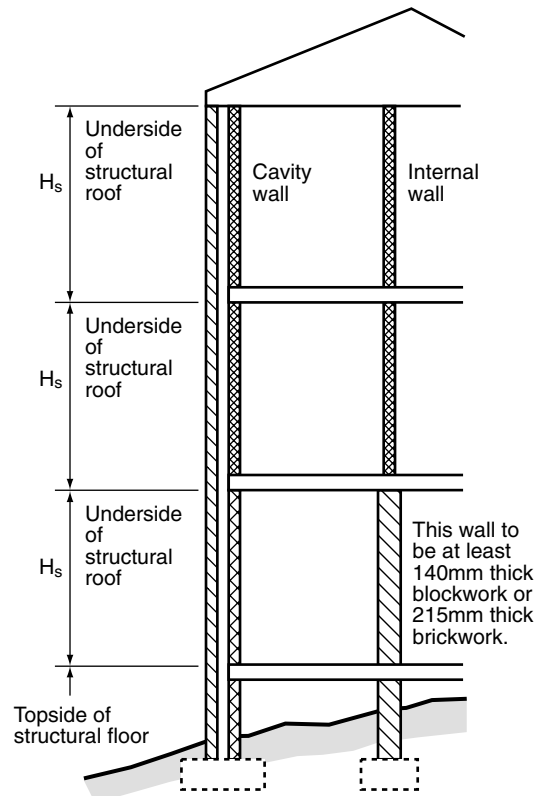

c. Three Storeys

Notes

- 1 If H_s is not greater than 2.7m, the compressive strength of bricks or blocks should be used in walls as indicated by the key.
- 2 If H_s is greater than 2.7m, the compressive strength of bricks or blocks used in the wall shall either be at least 7N/sq mm or as indicated by the key, whichever is the greater.

- 3 If the external wall is solid construction the masonry units should have a compressive strength of at least that shown for the internal leaf of a cavity wall in the same position.
- 4 The guidance given in the diagram for walls of two and three storey buildings should only be used to determine the compressive strength of the masonry units where the roof construction is of timber.

Diagram 10 Declared compressive strength of masonry units

See para 2C21

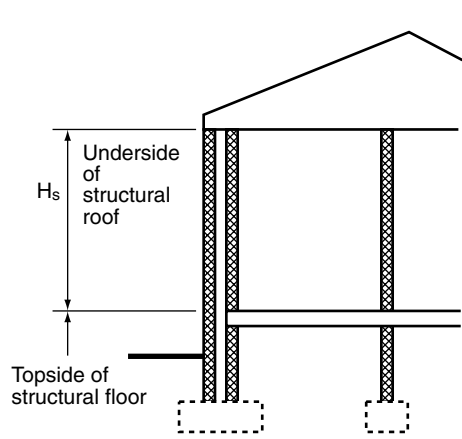

a. One Storey

Key

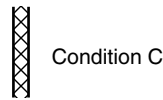

Where H_f Less than or equal to 1m, Condition A
 Where H_f Greater than 1m, Condition B

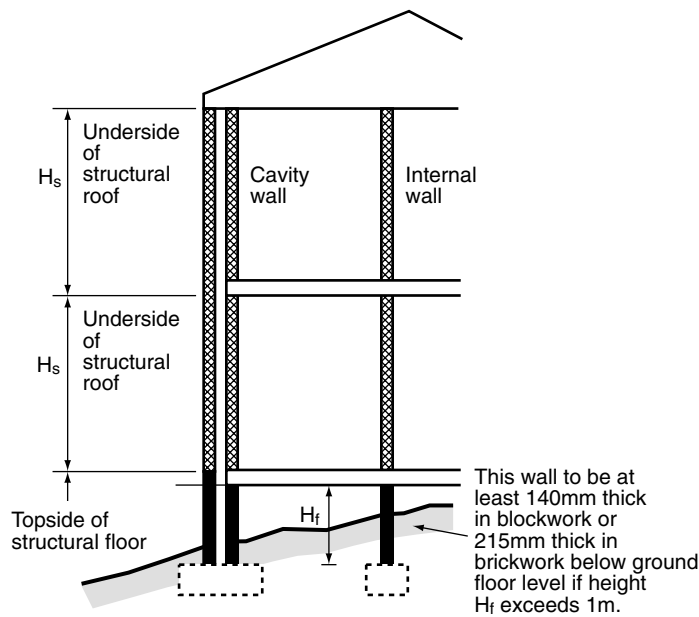

b. Two Storeys

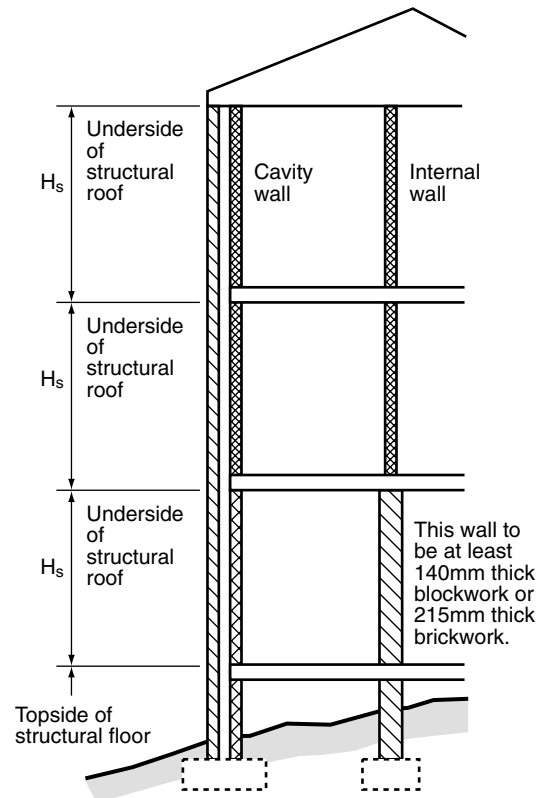

c. Three Storeys

Notes

1 If H_s is not greater than 2.7m, the compressive strength of bricks or blocks should be used in walls as indicated by the key.

2 If H_s is greater than 2.7m, the compressive strength of bricks or blocks used in the wall should be at least Condition B, or as indicated by the key, whichever is the greater.

3 If the external wall is solid construction, the masonry units should have a compressive strength of at least that shown for the internal leaf of a cavity wall in the same position.

4 The guidance given in the diagram for walls of two and three storey buildings should only be used to determine the compressive strength of the masonry units where the roof construction is of timber.

Table 7 Normalised compressive strength of masonry units of clay and calcium silicate blocks complying with BS EN 771-1 and 2 (N/mm²)

Standard	Condition (See diagram 10)	Group 1 masonry units	Group 2 masonry units
Clay masonry units to BS EN 771-1 Calcium silicate masonry units to BS EN 771-2	A	5.0	8.0
	B	7.5	11.0
	C	15.0	21.0

Notes:

- 1 Values in this Table are normalised compressive strengths (N/mm²). Compressive strengths of masonry units should be derived according to EN 772-1.
- 2 The Table applies to clay and calcium silicate block masonry units where the work size exceeds 337.5mm in length or 112.5mm in height.
- 3 Group 1 masonry units have not more than 25% formed voids (20% for frogged bricks). Group 2 masonry units have formed voids greater than 25%, but not more than 55%.

2C22 Mortar: Mortar should be:

- a.
 - i. Mortar designation (iii) according to BS 5628:Part 3:2001
 - ii. Strength class M4 according to BS EN 998 - 2
 - iii. 1:1: 5 or 6 CEM 1, lime and fine aggregate measured by volume of dry materials, or
- b. of equivalent or greater strength and durability to the specification in a. above.

Loading on walls

2C23 Maximum span of floors: The maximum span for any floor supported by a wall is 6m where the span is measured centre to centre of bearing. (see Diagram 11)

2C24 Other loading conditions:

- a. Vertical loading on walls should be distributed. This may be assumed for concrete floor slabs, precast concrete floors, and timber floors designed in accordance with Section 2B, and where the bearing length for lintels is 150mm or greater. Where a lintel has a clear span of 1200mm or less the bearing length may be reduced to 100mm.
- b. differences in level of ground or other solid construction between one side of the wall and the other should be less than 4 times the thickness of the wall as shown in Diagram 12.
- c. the combined dead and imposed load should not exceed 70kN/m at base of wall. (see Diagram 12)
- d. walls should not be subjected to lateral load other than from wind, and that covered by paragraph 2C24(b).

Diagram 11 Maximum span of floors

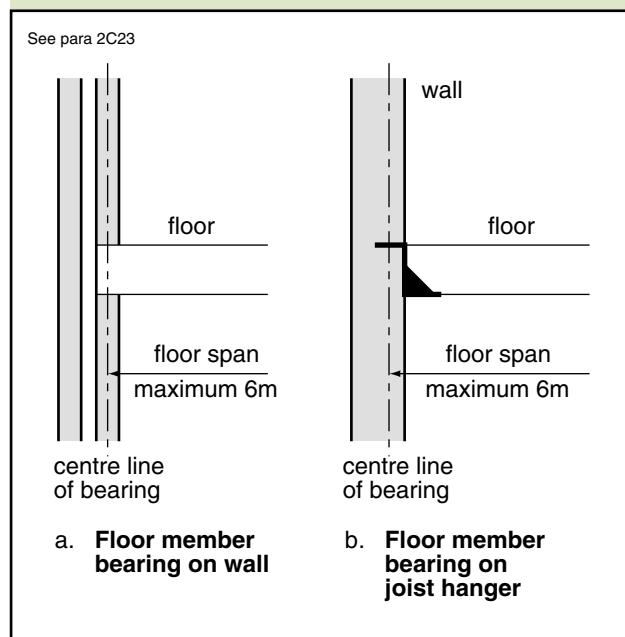

End restraint

2C25 Vertical Lateral Restraint to Walls

The ends of every wall should be bonded or otherwise securely tied throughout their full height to a buttressing wall, pier or chimney. Long walls may be provided with intermediate buttressing walls, piers or chimneys dividing the wall into distinct lengths within each storey; each distinct length is a supported wall for the purposes of this section. The intermediate buttressing walls, piers or chimneys should provide lateral restraint to the full height of the supported wall, but they may be staggered at each storey.

2C26 **Buttressing Walls**

If the buttressing wall is not itself a supported wall its thickness T2 should not be less than :

Continued on page 26

Diagram 12 Differences in ground levels

See para 2C24b

a. Situations where differences in level may occur

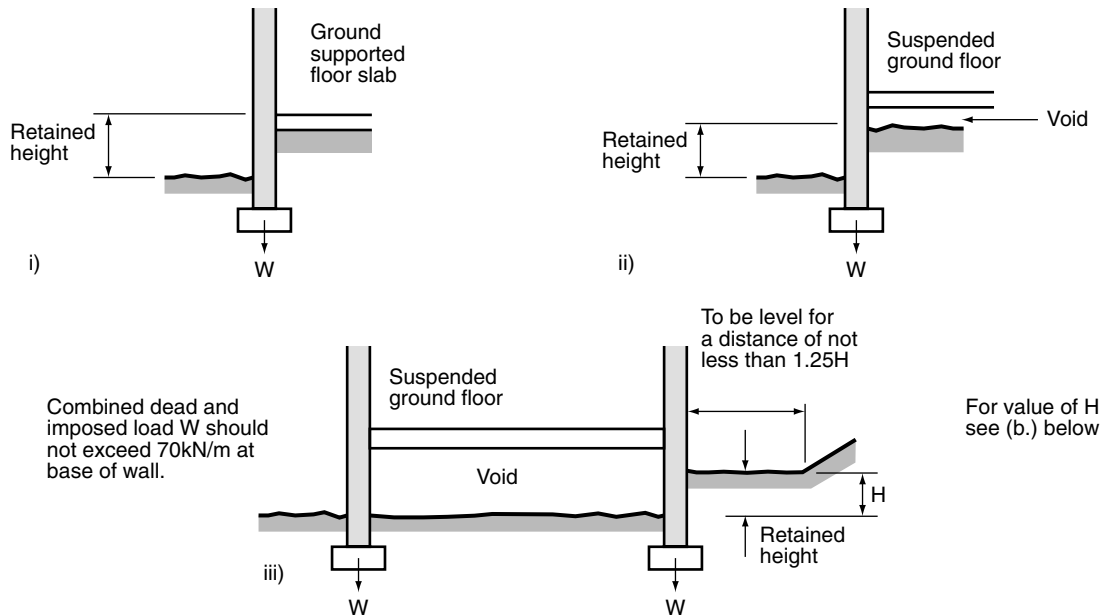

b. Maximum differences in permitted level

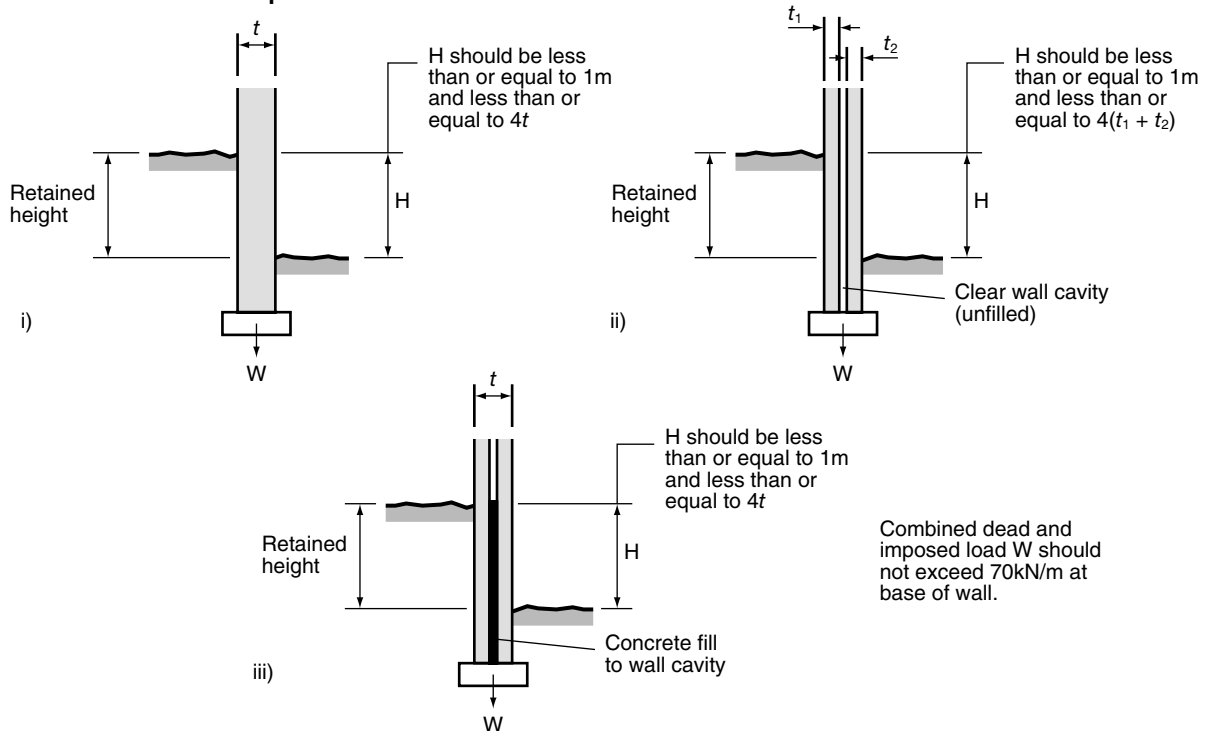

Notes

- 1 Floor slabs in figure b have been omitted for clarity and may be on either side of the walls shown.
- 2 Cavity walls should be tied in accordance with Table 5.

3 These recommendations apply only to circumstances where there is a full storey height of masonry above the upper retained level.

Diagram 13 Openings in a buttressing wall

See para 2C26

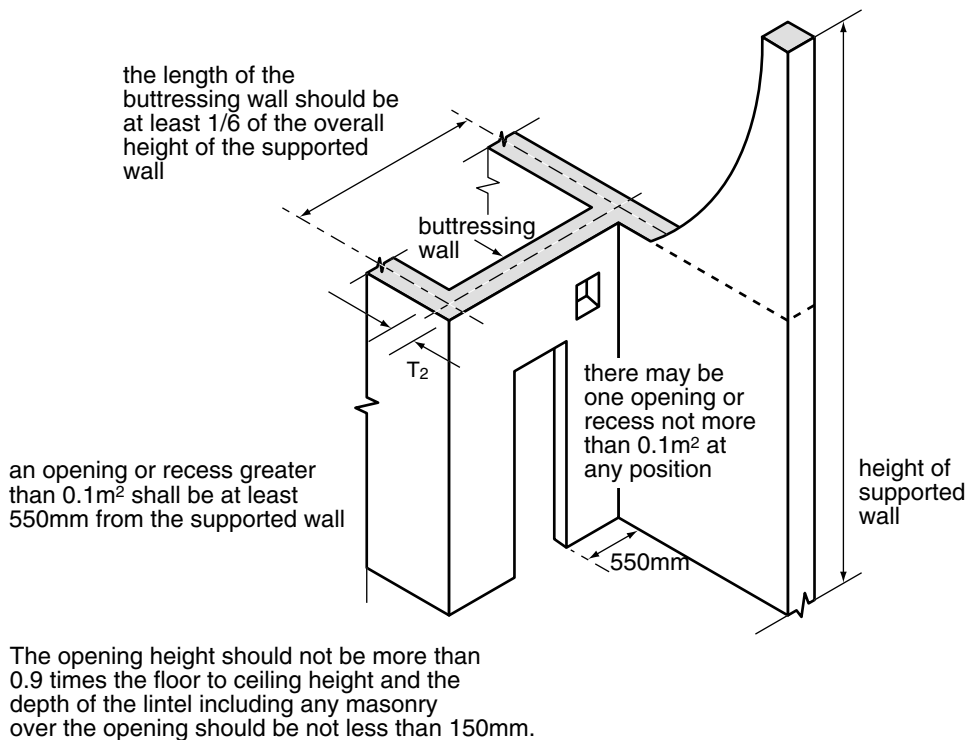

Notes

- 1 The buttressing wall should be bonded or securely tied to the supported wall and at the other end to a buttressing wall, pier or chimney.
- 2 Openings or recesses in the buttressing wall should be as shown – the

position and shape of the openings should not impair the lateral support to be given by the buttressing wall.

- 3 Refer to Diagram 8 for the rules for measuring the height of the supported wall.

- a. half the thickness required by this section for an external or separating wall of similar height and length less 5mm, or
- b. 75mm if the wall forms part of a dwelling house and does not exceed 6m in total height and 10m in length, and
- c. 90mm in other cases.

The length of the buttressing wall should be at least $\frac{1}{6}$ of the overall height of the supported wall and be bonded or securely tied to the supporting wall and at the other end to a buttressing wall, pier or chimney.

The size of any opening in the buttressing wall should be restricted as shown in Diagram 13.

2C27 Design criteria for piers and chimneys providing restraint:

- a. piers should measure at least 3 times the thickness of the supported wall and chimneys twice the thickness, measured at right angles

to the wall. Piers should have a minimum width of 190mm (see Diagram 14)

- b. the sectional area on plan of chimneys (excluding openings for fireplaces and flues) should be not less than the area required for a pier in the same wall, and the overall thickness should not be less than twice the required thickness of the supported wall. (see Diagram 14)

Openings, recesses, overhangs and chases

2C28 General:

The number, size and position of openings and recesses should not impair the stability of a wall or the lateral restraint afforded by a buttressing wall to a supported wall. Construction over openings and recesses should be adequately supported.

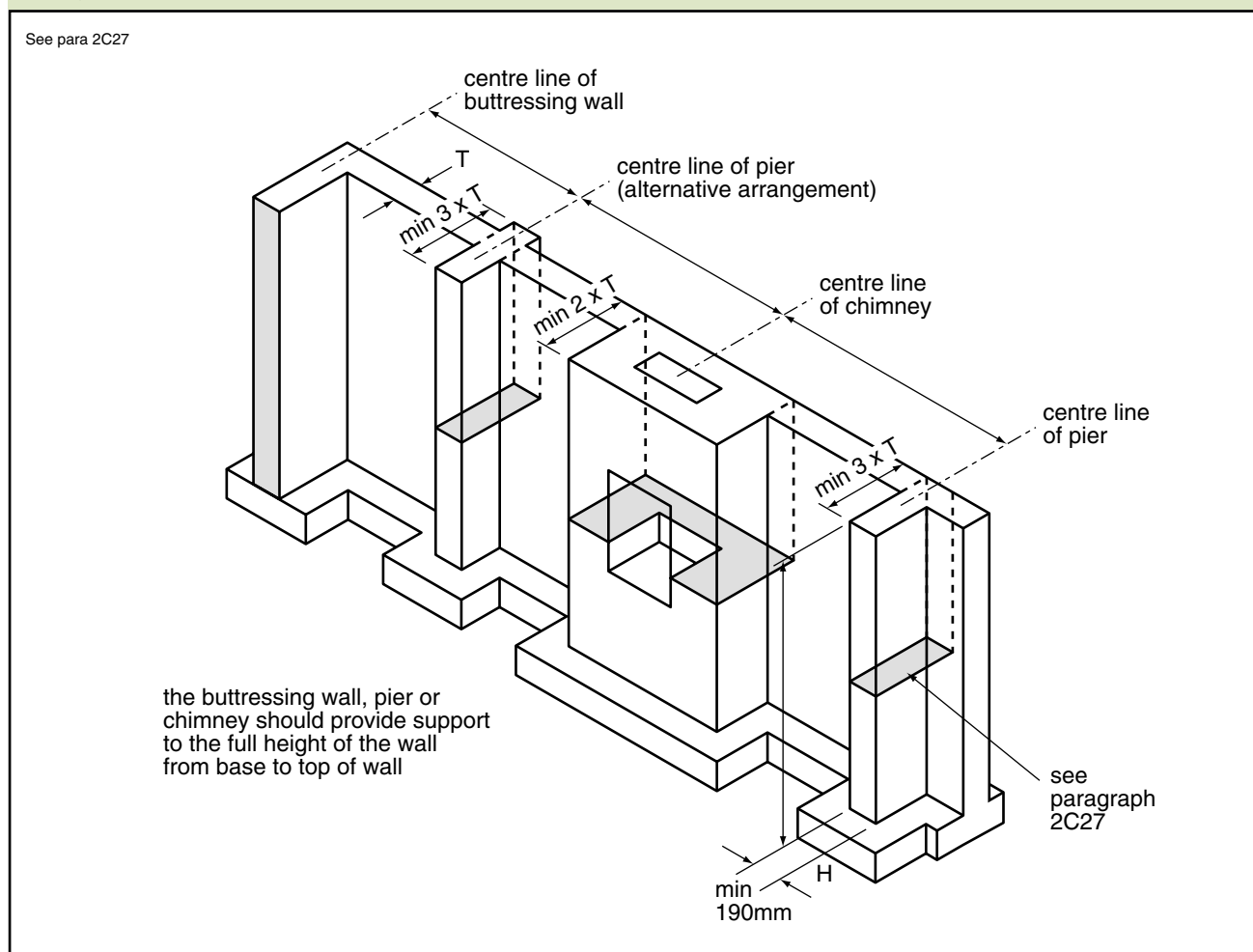
Diagram 14 **Buttressing****2C29 Dimensional criteria for openings and recesses:**

The dimensional criteria are given in Diagrams 15 and Table 8.

No openings should be provided in walls below ground floor except for small holes for services and ventilation etc. which should be limited to a maximum area of 0.1m² at not less than 2m centres.

2C30 Chases:

- vertical chases should not be deeper than 1/3 of the wall thickness or, in cavity walls, 1/3 of the thickness of the leaf.
- horizontal chases should not be deeper than 1/6 of the thickness of the leaf of the wall.
- chases should not be so positioned as to impair the stability of the wall, particularly where hollow blocks are used.

2C31 Overhangs:

the amount of any projection should not impair the stability of the wall.

Lateral support by roofs and floors

2C32 A wall in each storey of a building should extend to the full height of that storey, and have horizontal lateral supports to restrict movement of the wall at right angles to its plane.

2C33 Floors and roofs should:

- act to transfer lateral forces from walls to buttressing walls, piers or chimneys, and
- be secured to the supported wall by connections specified in paragraphs 2C34 and 2C35.

2C34 The requirements for lateral restraint of walls at roof and floor levels are given in Table 9 and guidance on satisfying the requirements is given in paragraphs **2C35** and **2C36**.

2C35 Walls should be strapped to floors above ground level, at intervals not exceeding 2m and as shown in Diagram 16 by tension straps conforming to BS EN 845-1. For corrosion resistance purposes, the tension straps should be material reference 14 or 16.1 or 16.2 (galvanised steel) or other more resistant

Diagram 15 Sizes of openings and recesses

See para 2C29

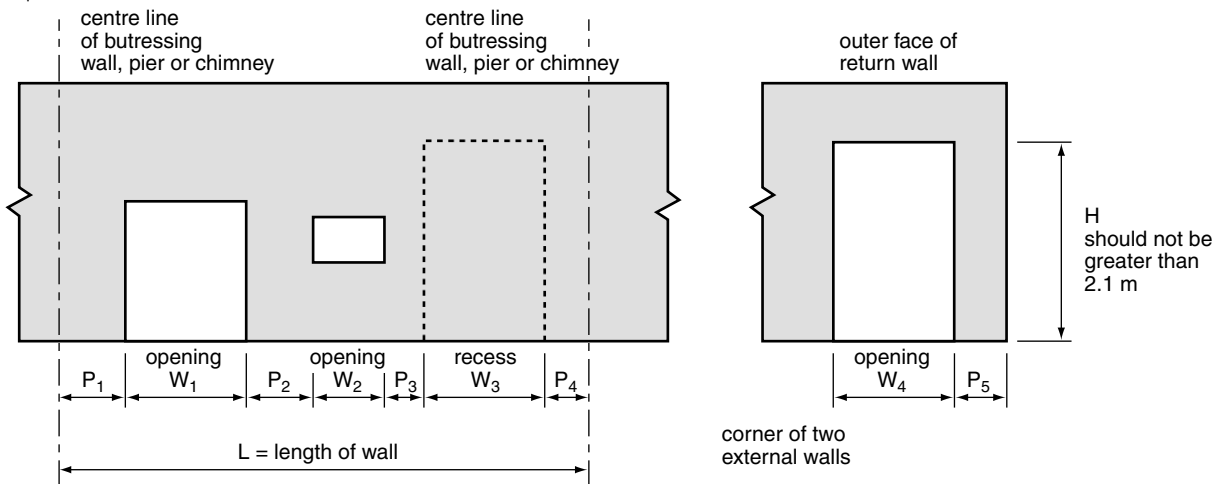

Notes

Requirements (refer to Table 6 or values of factor X).

- 1 $W_1 + W_2 + W_3$ should not exceed $\frac{2L}{3}$
- 2 $W_1 + W_2 + W_3$ should not exceed 3m
- 3 P_1 should be greater than or equal to $\frac{W_1}{X}$
- 4 P_2 should be greater than or equal to $\frac{W_1 + W_2}{X}$

5 P_3 should be greater than or equal to $\frac{W_2 + W_3}{X}$

6 P_4 should be greater than or equal to $\frac{W_3}{X}$

7 P_5 should be greater than or equal to $\frac{W_4}{X}$ but should not be less than 665mm.

8 Take the value of the fact X from Table 6, or it can be give the value 6, provided the compressive strength of the bricks or blocks (in the case of a cavity wall – in the loaded leaf) is not less than 7N/mm².

Table 8 Value of factor 'x' (see diagram 15)

Nature of roof span	Maximum roof span (m)	Minimum thickness of wall inner (mm)	Span of floor is parallel to wall	Span of timber floor into wall		Span of concrete floor into wall	
				max 4.5m	max 6.0m	max 4.5m	max 6.0m
Value of factor 'X'							
roof spans parallel to wall	non applicable	100	6	6	6	6	6
		90	6	6	6	6	5
timber roof spans into wall	9	100	6	6	5	4	3
		90	6	4	4	3	3

Table 9 Lateral support for walls

Wall type	Wall length	Lateral support required
solid or cavity: external compartment separating	any length	roof lateral support by every roof forming a junction with the supported wall
	greater than 3m	floor lateral support by every floor forming a junction with the supported wall
Internal load-bearing wall (not being a compartment or separating wall)	any length	roof or floor lateral support at the top of each storey

Diagram 16 Lateral support by floors

See para 2C35

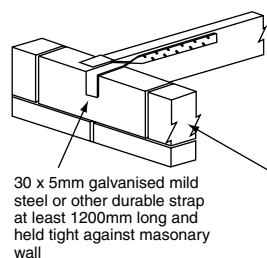

30 x 5mm galvanised mild steel or other durable strap at least 1200mm long and held tight against masonry wall

a. Tension Strap Detail - 1

Internal leaf of external cavity wall or internal wall requiring lateral restraint

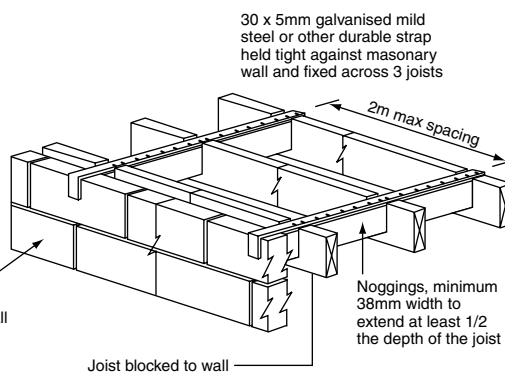

30 x 5mm galvanised mild steel or other durable strap held tight against masonry wall and fixed across 3 joists

2m max spacing

Noggings, minimum 38mm width to extend at least 1/2 the depth of the joist

Joist blocked to wall

b. Tension Strap Detail - 2

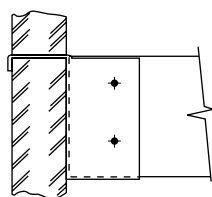

c. Restraint Type Joist Hanger

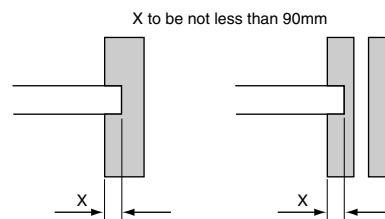

X to be not less than 90mm

X

X

d. Restraint by Concrete Floor or Roof

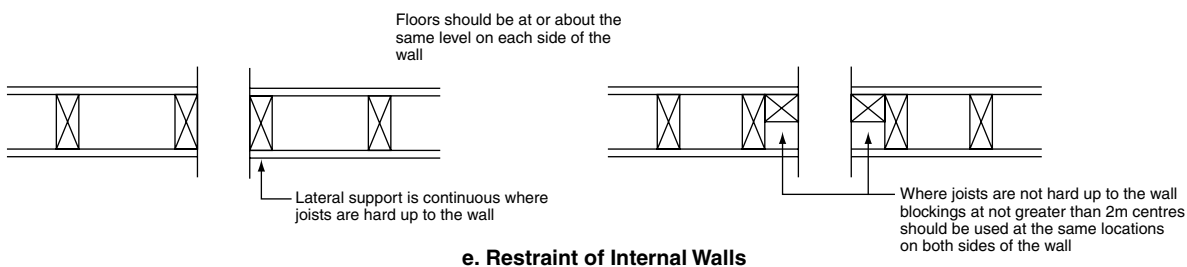

Floors should be at or about the same level on each side of the wall

Lateral support is continuous where joists are hard up to the wall

Where joists are not hard up to the wall blockings at not greater than 2m centres should be used at the same locations on both sides of the wall

e. Restraint of Internal Walls

specifications including material references 1 or 3 (austenitic stainless steel). The declared tensile strength of tension straps should not be less than 8 kN.

Tension straps need not be provided:

- a. in the longitudinal direction of joists in houses of not more than 2 storeys, if the joists are at not more than 1.2m centres and have at least 90mm bearing on the supported walls or 75mm bearing on a timber wall-plate at each end, and
- b. in the longitudinal direction of joists in houses of not more than 2 storeys, if the joists are carried on the supported wall by joist hangers in accordance with BS EN 845-1 of the restraint type described in BS 5628: Part 1 and shown in Diagram 16(c), and are incorporated at not more than 2m centres, and
- c. when a concrete floor has at least 90mm bearing on the supported wall (see Diagram 16(d)), and
- d. where floors are at or about the same level on each side of a supported wall, and

contact between the floors and wall is either continuous or at intervals not exceeding 2m. Where contact is intermittent, the points of contact should be in line or nearly in line on plan. (see Diagram 16(e))

2C36 Gable walls should be strapped to roofs as shown in Diagram 17(a) and (b) by tension straps as described in 2C35.

Vertical strapping at least 1m in length should be provided at eaves level at intervals not exceeding 2m as shown in Diagram 17 (c) and (d). Vertical strapping may be omitted if the roof:

- a. has a pitch of 15° or more, and
- b. is tiled or slated, and
- c. is of a type known by local experience to be resistant to wind gusts, and
- d. has main timber members spanning onto the supported wall at not more than 1.2m centres.

Diagram 17 Lateral support at roof level

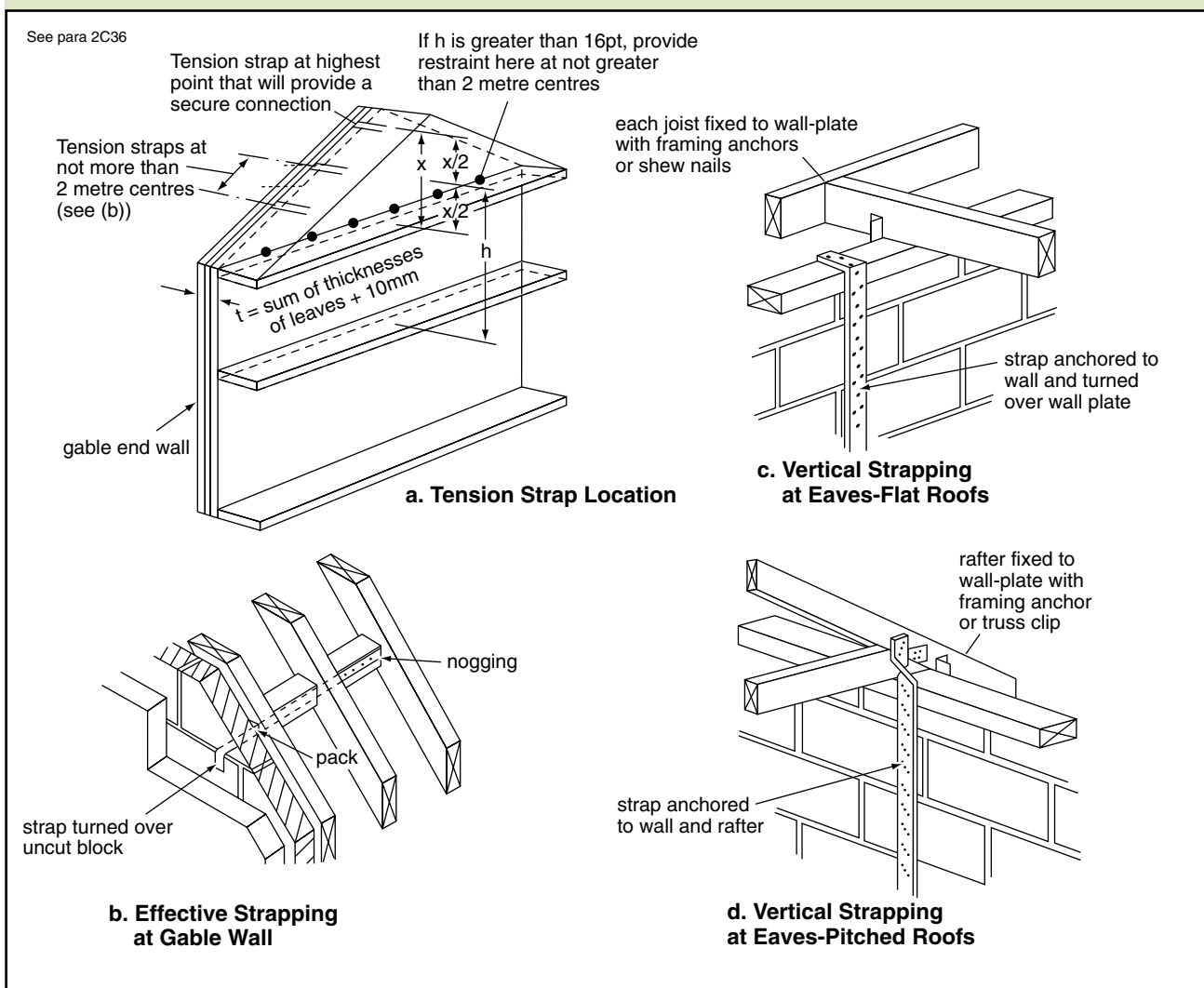

Interruption of lateral support

2C37 Where an opening in a floor or roof for a stairway or the like adjoins a supported wall and interrupts the continuity of lateral support, the following conditions should be satisfied for the purposes of Section 2C:

- the maximum permitted length of the opening is to be 3m, measured parallel to the supported wall, and
- where a connection is provided by means other than by anchor, this should be provided throughout the length of each portion of the wall situated on each side of the opening, and
- where connection is provided by mild steel anchors, these should be spaced closer than 2m on each side of the opening to provide the same number of anchors as if there were no opening, and
- there should be no other interruption of lateral support.

Small single-storey non-residential buildings and annexes

2C38 Size and proportion

(i) General

The guidance given applies in the following circumstances:-

- The floor area of the building or annexe does not exceed 36m^2
- The walls are solidly constructed in brickwork or blockwork using materials which comply with paragraphs 2C19 to 2C22.
- Where the floor area of the building or annexe exceeds 10m^2 the walls have a mass of not less than 130 kg/m^2 .

Note: There is no surface mass limitation recommended for floor areas of 10m^2 or less.

- Access to the roof is only for the purposes of maintenance and repair.
- The only lateral loads are wind loads.

Diagram 18 Size and location of openings

See para 2C38

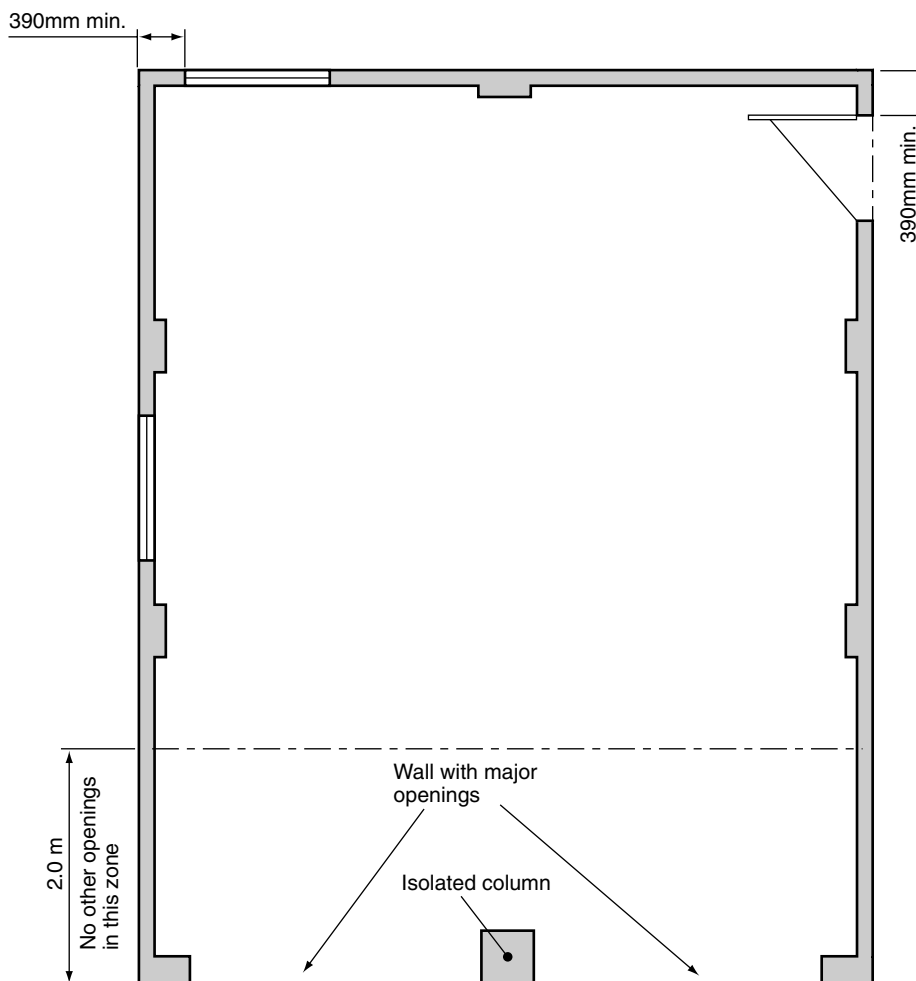

Notes

- 1** Major opening should be restricted to one wall only. Their aggregate width should not exceed 5.0m and their height should not be greater than 2.1m
- 2** There should be no other openings within 2.0m of a wall containing a major opening.

- 3** The aggregate size of openings in a wall not containing a major opening should not exceed 2.4m².
- 4** There should not be more than one opening between piers.
- 5** Unless there is a corner pier the distance from a window or a door to a corner should not be less than 390mm.

- f. The maximum length or width of the building or annexe does not exceed 9m.
- g. The height of the building or annexe does not exceed the lower value derived from Diagram 2.
- h. The roof is braced at rafter level, horizontally at eaves level and at the base of any gable by roof decking, rigid sarking or diagonal timber bracing, as appropriate, in accordance with BS 5268 : Part 3.

- i. Walls are tied to the roof structure vertically and horizontally in accordance with paragraphs 2C32 to 2C36 and with horizontal lateral restraint at roof level in accordance with paragraph (iv) below.
- j. The roof structure of an annexe is secured to the structure of the main building at both rafter and eaves level.

Diagram 19 Wall thickness

See para 2C38

a. Wall without a Major Opening

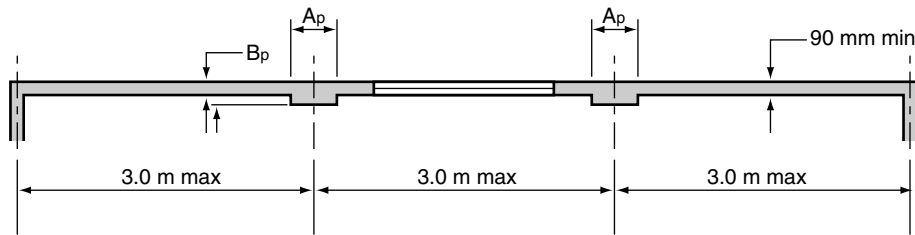

b. Wall with a Single Major Opening

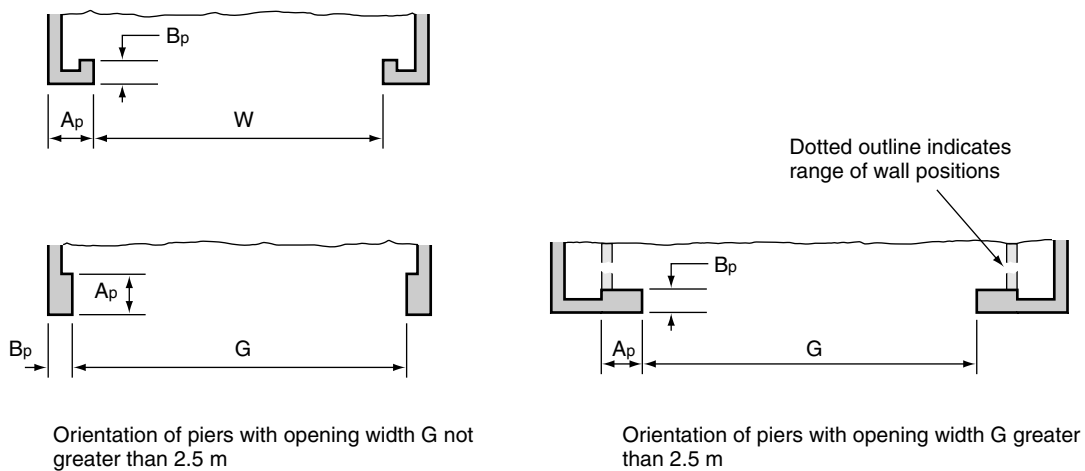

c. Wall with Two Major Openings

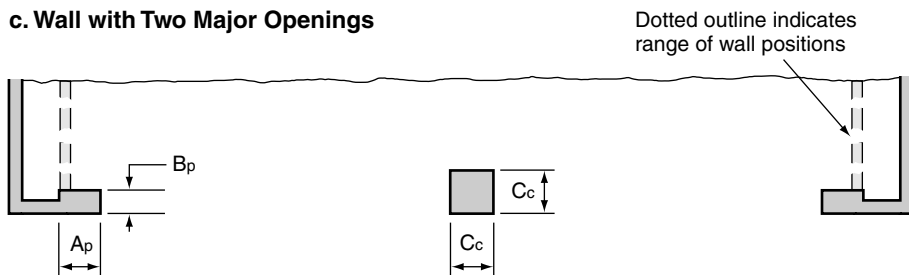

Notes

1 In all cases the minimum pier size (A_p x B_p) should be 390mm x 190mm or 327mm x 215mm depending on the size of the masonry units.

2 Isolated column (Case c) to be 325mm x 325mm minimum (C_c x C_c)

(ii) Size and location of openings

One or two major openings not more than 2.1m in height are permitted in one wall of the building or annexe only. The width of a single opening or the combined width of two openings should not exceed 5m.

The only other opening permitted in a building or annexe are for windows and a single leaf

door. The size and location of these openings should be in accordance with Diagram 18.

(iii) Wall thickness and recommendations for piers

The walls should have a minimum thickness of 90mm.

Diagram 20 Lateral restraint at roof level

See para 2C38

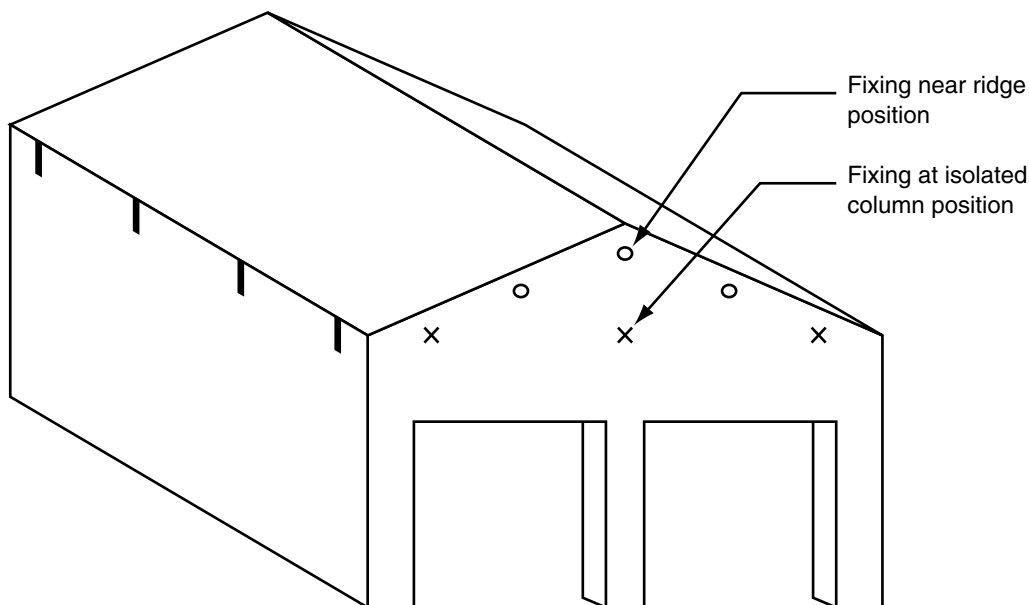

Key

- ┆ denotes fixings at eaves level.
- X denotes fixings at base of gable.
- denotes fixings along roof slope.

Note: Fixings should be in accordance with Diagram 17.

Walls which do not contain a major opening but exceed 2.5m in length or height should be bonded or tied to piers for their full height at not more than 3m centres as shown in Diagram 19a. Walls which contain one or two major openings should in addition have piers as shown in Diagrams 19b and 19c. Where ties are used to connect piers to walls they should be flat, 20mm x 3mm in cross section, be in stainless steel in accordance with clause 2C19, be placed in pairs and be spaced at not more than 300mm centre vertically.

using suitable fixings. Isolated columns should also be tied to the roof structure (see Diagram 20).

(iv) Horizontal lateral restraint at roof level

Walls should be tied horizontally at no more than 2m centres to the roof structure at eaves level, base of gables and along roof slopes as shown in Diagram 20 with straps fixed in accordance with paragraphs 2C35 and 2C36. Where straps cannot pass through a wall they should be adequately secured to the masonry

Section 2D: Proportions for Masonry Chimneys above the roof surface

Height to width relationship

2D1 Where a chimney is not adequately supported by ties or securely restrained in any way, its height if measured from the highest point of intersection with the roof surface, gutter, etc. should not exceed $4.5W$, provided the density of the masonry is greater than 1500kg/m^3 , where:

W is the least horizontal dimension of the chimney measured at the same point of intersection, and

H is measured to the top of any chimney pot or other flue terminal.(see Diagram 21)

Diagram 21 Proportions for masonry chimneys

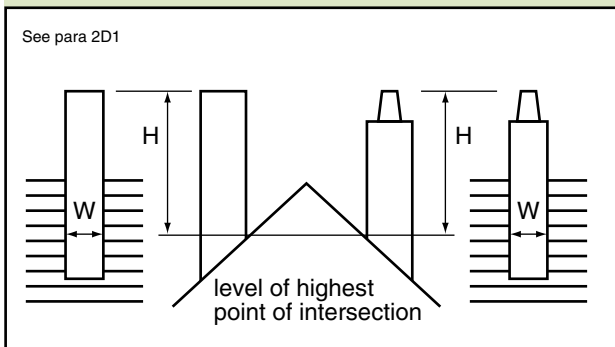

Section 2E: Foundations of Plain Concrete

Conditions relating to the ground

2E1 There should not be:

- a. non-engineered fill (as described in BRE Digest 427) or wide variation in ground conditions within the loaded area, nor
- b. weaker or more compressible ground at such a depth below the foundation as could impair the stability of the structure.

Design provisions

2E2 The following design provisions relate to foundations:

- a. the foundations should be situated centrally under the wall
 - b. for foundations in chemically aggressive soil conditions guidance in BS 8500-1 : Part 1 and BRE Special Digest 1 should be followed. In non-aggressive soils, concrete should be composed of Portland Cement to BS EN 197 - 1 & 2 and fine and coarse aggregate conforming to BS EN 12620 and the mix should comply with one of the following recommendations:
 - i. in proportion of 50 kg of Portland cement to not more than 200kg (0.1m³) of fine aggregate and 400 kg (0.2 m³) of coarse aggregate, or
 - ii. Grade ST2 or Grade GEN I concrete to BS 8500-2
 - c. minimum thickness T of concrete foundation should be 150mm or P, whichever is the greater where P is derived using Table 10 and Diagram 24. Trench fill foundations may be used as an acceptable alternative to strip foundations.
 - d. foundations stepped on elevation should overlap by twice the height of the step, by the thickness of the foundation, or 300mm, whichever is greater (see Diagram 22).
- For trench fill foundations the overlap should be twice the height of step or 1 metre, whichever is greater.
- e. steps in foundations should not be of greater height than the thickness of the foundation (see Diagram 22).
 - f. foundation of piers buttresses and chimneys should project as indicated in Diagram 23 and the projection X should never be less than the value of P where there is no local thickening of the wall.

Minimum width of strip foundations

2E3 The recommended minimum widths of foundations given in Table 10 may be used.

Diagram 22 Elevation of stepped foundation

See para 2E2d and e

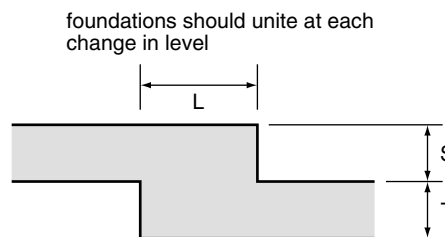

minimum overlap L = twice height of step, or thickness of foundation or 300mm, whichever is greater

S should not be greater than T

(For trench fill foundations, minimum overlap L = twice height of step, or 1 metre, whichever is greater)

Diagram 23 Piers and chimneys

See para 2E2f

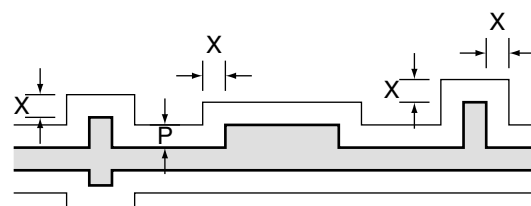

projection X should not be less than P

Diagram 24 Foundation dimensions

See para 2E2c

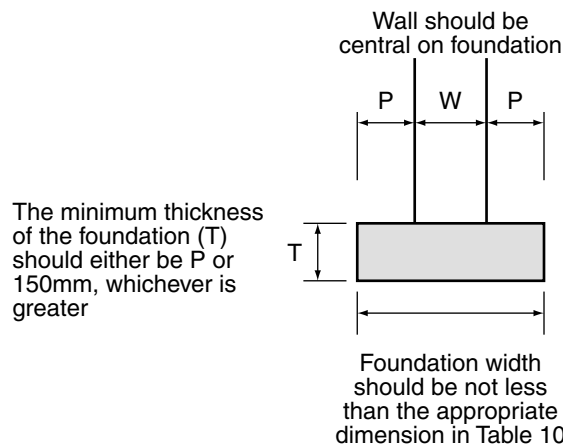

Trench fill foundations may be used as an alternative to strip foundations.

Table 10 Minimum width of strip footings

Type of Ground (including engineered fill)	Condition of ground	Field test Applicable	Total load of load-bearing walling not more than (kN/linear metre)					
			20	30	40	50	60	70
			Minimum width of strip foundation (mm)					
I Rock	Not inferior to sandstone, limestone or firm chalk	Requires at least a pneumatic or other mechanically operated pick for excavation	In each case equal to the width of wall					
II Gravel or Sand	Medium dense	Requires pick for excavation. Wooden peg 50mm square in cross section hard to drive beyond 150mm	250	300	400	500	600	650
III Clay Sandy Clay	Stiff Stiff	Can be indented slightly by thumb	250	300	400	500	600	650
IV Clay Sandy Clay	Firm Firm	Thumb makes impression easily	300	350	450	600	750	850
V Sand Silty sand Clayey sand	Loose Loose Loose	Can be excavated with a spade. Wooden peg 50mm square in cross section can be easily driven	400	600	Note Foundations on soil types V and V1 do not fall within the provisions of this section if the total load exceeds 30 kN/m.			
VI Silt Clay Sandy clay Clay or silt	Soft Soft Soft Soft	Finger pushed in up to 10mm	450	650				
VII Silt Clay Sandy clay Clay or silt	Very soft Very soft Very soft Very soft	Finger easily pushed in up to 25mm	Refer to specialist advice					

The table is applicable only within the strict terms of the criteria described within it.

Minimum Depth of Strip Foundations

2E4 Except where strip foundations are founded on rock, the strip foundations should have a minimum depth of 0.45m to their underside to avoid the action of frost. This depth however, will commonly need to be increased in areas subject to long periods of frost or in order to transfer the loading onto satisfactory ground.

In clay soils subject to volume change on drying ('shrinkable clays', with Plasticity Index greater than or equal to 10%), strip foundations should be taken to a depth where anticipated ground movements will not impair the stability of any part of the building taking due consideration of the influence of vegetation and trees on the ground. The depth to the underside of foundations on clay soils should not be less than 0.75m although this depth will commonly need to be increased in order to transfer the loading onto satisfactory ground.

Section 3: Wall Cladding

General

3.1 Wall cladding presents a hazard if it becomes detached from the building. This Section provides guidance on the support and fixing of wall cladding. An acceptable level of safety can be achieved by different means depending on the type and location of the cladding. The guidance given relates to all forms of cladding, including curtain walling and glass facades. It is not intended to provide guidance concerning the weather resistance of wall cladding which is included in Approved Document C Site preparation and resistance to moisture, or guidance on resistance to spread of fire which is included in Approved Document B, Fire Safety, or guidance in relation to sound insulation, which is included in Approved Document E, Resistance to the Passage of Sound.

Technical Approach

3.2 The cladding will meet the safety requirement if:

- a. the cladding is capable of safely sustaining and transmitting to the supporting structure of the building all dead, imposed and wind loads, and
- b. the cladding is securely fixed to and supported by the structure of the building. This shall comprise both vertical support and horizontal restraint, and
- c. provision is made, where necessary, to accommodate differential movement of the cladding and the supporting structure of the building, and
- d. the cladding and its fixings (including any support components) are of durable materials; the design life of the fixings being not less than that of the cladding. Fixings shall be corrosion resistant and of a material type appropriate for the local environment.

Loading

3.3 Wind loading on the cladding should be derived from BS 6399, Part 2: 2001 with due consideration given to local increases in wind suction arising from funnelling of the wind through gaps between buildings. Guidance on funnelling effects is given in BRE Digest 436 Wind loading on buildings - Brief guidance for using BS 6399-2: 1997 available from BRE, Bucknalls Lane, Garston, Watford, Herts WD2 7JR.

3.4 Where the cladding is required to support other fixtures e.g. handrails, and fittings, e.g. antennae and signboards, account should be taken of the loads and forces arising from such fixtures and fittings.

3.5 Where the wall cladding is required to function as pedestrian guarding to stairs, ramps, vertical drops of 600mm or greater or as a vehicle barrier, then account should be taken of the additional imposed loading, as stipulated in Approved Document K: Protection from falling, collision and impact.

3.6 Where the wall cladding is required to safely withstand lateral pressures from crowds, an appropriate design loading is given in BS 6399 Part 1 and the Guide to Safety at Sports Grounds (4th Edition, 1997).

Fixings

3.7 The selection of fixings for supporting cladding should be determined from a consideration of the proven performance of the fixing and the risks associated with the particular application. In this regard applications should be designated as being either non-redundant (where the failure of a single fixing could lead to the detachment of the cladding) or redundant (where failure or excessive movement of one fixing results in load sharing by adjacent fixings) and the required reliability of the fixing determined accordingly.

Note: Attention is drawn to the availability of anchors with an ETA (European Technical Approval) gained in accordance with the requirements of ETAG 001 Guideline for European Technical Approval *Metal Anchors for use in Concrete* Parts 1-5, which cover both redundant and non-redundant applications, and Part 6 which covers "Anchors for multiple use in non-structural applications" and which can effectively be regarded as covering redundant use. The UK definition of "Multiple use" is contained in an annex to the ETAG Part 6 and is framed in such a way that all applications can be validated as to whether or not they conform to this category without calculation. All ETAG parts may be downloaded in English from www.eota.be.

3.8 The strength of fixings should be derived from tests using materials representative of the material into which the fixing is to be anchored, taking account of any inherent weaknesses that may affect the strength of the fixing, eq. cracks in concrete due to shrinkage and flexure, or voids in masonry construction. The design loads will generally be available from the manufacturer's test data determined from a European Technical Approval (ETA) or an extant British Standard

Note: ETAS are available which cover use either in both cracked and non-cracked concrete or in non-cracked concrete only. Those which cover both cracked and non-cracked concrete allow higher loads for use in non-cracked than in cracked concrete. Guidance on how to

determine whether a particular concrete section may be regarded as cracked or non-cracked without reverting to stress calculations is contained in "Use of anchors with European Technical Approvals. UK Guidance - Distinction between cracked and non-cracked concrete". This is available on the BBA website www.bbacerts.co.uk click tab "ETA".

Further Guidance

3.9 The use of large panels of glass in cladding of walls and roofs where the cladding is not divided into small areas by load bearing framing requires special consideration. Guidance is given in the following documents:

The Institution of Structural Engineers' Report on 'Structural use of glass in buildings' dated 1999, available from 11 Upper Belgrave Street, London SW1X 8BH.

'Nickel sulfide in toughened glass' published by the Centre for Window Cladding and Technology dated 2000.

3.10 Further guidance on cladding is given in the following documents -

The Institution of Structural Engineers' Report on 'Aspects of Cladding' dated 1995.

The Institution of Structural Engineers' Report on 'Guide to the structural use of adhesives' dated 1999.

BS 8297 Code of practice for the design and installation of non-load bearing precast concrete cladding.

BS 8298 Code of practice for the design and installation of natural stone cladding and lining.

3.11 Additional guidance on fixings is given in the following documents -

ETAG No. 001 1997 Guideline for European Technical Approvals of Metal Anchors for use in Concrete, European Organisation for Technical Approvals, (EOTA) Brussels. All EOTA parts may be downloaded in English from www.eota.be

English version published by the British Board of Agreement, P 0 Box 195, Bucknalls Lane, Garston, Watford, Hertfordshire WD25 9BA.

Part 1 Anchors in general

Part 2 Torque controlled anchors

Part 3 Undercut anchors

Part 4 Deformation controlled anchors

Part 5 Bonded anchors

Part 6 Metal anchors for redundant use in concrete for lightweight systems.

BS 5080 Structural fixings in concrete and masonry Part 1 1993 : Method of test for tensile loading.

CIRIA Report RP 566 Cladding Fixings : Good practice guidance, available from 6 Storey's Gate, London SW1P 3AU

CIRIA Reports C579 and C589 Retention of masonry facades - Best practice guide.

Guidance Notes published by the Construction Fixings Association, c/o Institute of Spring Technology, Henry Street, Sheffield, South Yorks S3 7EQ

Guidance Note: Procedure for Site Testing Construction Fixings (1994)

Guidance Note: European Technical Approvals for Construction Fixings (1998)

Guidance Note Anchor Selection (1995)

Guidance Note Fixings and Fire (1998)

Guidance Note: Anchor Installation (1996)

Guidance Note: Bonded Anchors (1999)

Guidance Note: Heavy Duty Expansion Anchors (1997)

Guidance Note: Fixings for Brickwork and Blockwork (1997)

Guidance Note: Undercut Anchors (1998)

Guidance Note: Fixings and Corrosion (2002)

Section 4: Roof Covering

Materials

4.1 All materials used to cover roofs, including transparent or translucent materials, but excluding windows of glass in residential buildings with roof pitches of not less than 15°, shall be capable of safely withstanding the concentrated imposed loads upon roofs specified in BS 6399 pt 3.

Recovering of Roofs

4.2 The recovering of roofs is commonly undertaken to extend the useful life of buildings. Roof structures may be required to carry underdrawing or insulation provided at a time later than their initial construction. This Section provides guidance on determining whether such work to a roof constitutes a material alteration under the Building Regulations.

4.3 Where the work involves a significant change in the applied loading the structural integrity of the roof structure and the supporting structure should be checked to ensure that upon completion of the work the building is not less compliant with requirement A1 than that of the original building.

4.4 A significant change in roof loading is when the loading upon the roof is increased by more than 15%.

4.5 Where such checking of the existing roof structure indicates that the construction is unable to sustain any proposed increase in loading (e.g. due to overstressed members or unacceptable deflection leading to ponding), appropriate strengthening work or replacement of roofing members should be undertaken. This is classified as a material alteration.

4.6 In carrying out the checks mentioned in paragraph 4.3 an increase of stress in a structural member arising from increased loading does not necessarily indicate that the roof structure is less compliant than the original roof provided an adequate factor of safety is maintained.

4.7 Where work will significantly decrease the roof dead loading, the roof structure and its anchorage to the supporting structure should be checked to ensure that an adequate factor of safety is maintained against uplift of the roof under imposed wind loading.

The Requirement

This Approved Document deals with the following Requirements which are contained in the Building Regulations 2000 (as amended by SI 2001/3335, SI 2002/440, SI 2002/2871 and SI 2003/2692).

<i>Requirement</i>	<i>Limits on application</i>
Disproportionate Collapse A3. The building shall be constructed so that in the event of an accident the building will not suffer collapse to an extent disproportionate to the cause.	

Guidance

Performance

In the Secretary of State's view the Requirement of A3 will be met by an appropriate choice of measures to reduce the sensitivity of a building to disproportionate collapse should an accident occur.

Introduction

0.1 The guidance in Section 5 deals with the means of meeting this performance criterion.

Section 5: Reducing the sensitivity of the building to disproportionate collapse in the event of an accident

5.1 The requirement will be met by adopting the following approach for ensuring that the building is sufficiently robust to sustain a limited extent of damage or failure, depending on the class of the building, without collapse.

- a.** Determine the Building Class from Table 11
- b. For Class 1 buildings** - Provided the building has been designed and constructed in accordance with the rules given in this Approved Document, or other guidance referenced under Section 1, for meeting compliance with requirement A1 and A2 in normal use, no additional measures are likely to be necessary.

- c. For Class 2A buildings** - Provide effective horizontal ties, or effective anchorage of suspended floors to walls, as described in the Codes and Standards listed under paragraph 5.2 for framed and load-bearing wall construction; the latter being defined in paragraph 5.3 below.

- d. For Class 2B buildings** - Provide effective horizontal ties, as described in the Codes and Standards listed under paragraph 5.2 for framed and load-bearing wall construction; (the latter being defined in paragraph 5.3 below), together with:
 - effective vertical ties, as defined in the Codes and Standards listed under

Table 11 Building Classes

Class	Building Type and Occupancy
1	Houses not exceeding 4 storeys. Agricultural buildings Buildings into which people rarely go, provided no part of the building is closer to another building, or area where people do go, than a distance of 1.5 times the building height
2A	5 storey single occupancy houses Hotels not exceeding 4 storeys Flats, apartments and other residential buildings not exceeding 4 storeys Offices not exceeding 4 storeys Industrial buildings not exceeding 3 storeys Retailing premises not exceeding 3 storeys of less than 2000m ² floor area in each storey Single storey educational buildings All buildings not exceeding 2 storeys to which members of the public are admitted and which contain floor areas not exceeding 2000m ² at each storey
2B	Hotels, flats, apartments and other residential buildings greater than 4 storeys but not exceeding 15 storeys Educational buildings greater than 1 storey but not exceeding 15 storeys Retailing premises greater than 3 storeys but not exceeding 15 storeys Hospitals not exceeding 3 storeys Offices greater than 4 storeys but not exceeding 15 storeys All buildings to which members of the public are admitted which contain floor areas exceeding 2000m ² but less than 5000m ² at each storey Car parking not exceeding 6 storeys
3	All buildings defined above as Class 2A and 2B that exceed the limits on area and/or number of storeys Grandstands accommodating more than 5000 spectators Buildings containing hazardous substances and/or processes

NOTE 1: For buildings intended for more than one type of use the Class should be that pertaining to the most onerous type.

NOTE 2: In determining the number of storeys in a building, basement storeys may be excluded provided such basement storeys fulfil the robustness requirements of Class 2B buildings.

- paragraph 5.2, in all supporting columns and walls, or alternatively,
- check that upon the notional removal of each supporting column and each beam supporting one or more columns, or any nominal length of load-bearing wall (one at a time in each storey of the building) that the building remains stable and that the area of floor at any storey at risk of collapse does not exceed 15% of the floor area of that storey or 70m², whichever is smaller, and does not extend further than the immediate adjacent storeys (see Diagram 25).

Where the notional removal of such columns and lengths of walls would result in an extent of damage in excess of the above limit, then such elements should be designed as a “key element” as defined in paragraph 5.3 below.

e. For Class 3 buildings - A systematic risk assessment of the building should be undertaken taking into account all the normal hazards that may reasonably be foreseen, together with any abnormal hazards.

Critical situations for design should be selected that reflect the conditions that can reasonably be foreseen as possible during the life of the building. The structural form and concept and any protective measures should then be chosen and the detailed design of the structure and its elements undertaken in accordance with the recommendations given in the Codes and Standards given in paragraph 5.2.

5.2 Details of the effective horizontal and vertical ties, together with the design approaches for checking the integrity of the building following the notional removal of vertical members and the design of key elements, are available in the following Codes and Standards:

BS5628: Part 1 – Structural use of unreinforced masonry

BS5950: Part 1 – Structural use of steelwork in building

BS8110: Part 1 – Structural use of plain, reinforced and prestressed concrete.

BS8110: Part 2 – ditto

5.3 Definitions

Nominal length of load-bearing wall

The nominal length of load-bearing wall construction referred to in 5.1d should be taken as follows :

- in the case of a reinforced concrete wall, the distance between lateral supports subject to a maximum length not exceeding 2.25H.
- in the case of an external masonry wall, or timber or steel stud wall, the length

measured between vertical lateral supports.

- in the case of an internal masonry wall, or timber or steel stud wall, a length not exceeding 2.25H.
- where H is the storey height in metres.

Key Elements

A “key element”, as referred to in paragraph 5.1d, should be capable of sustaining an accidental design loading of 34 kN/m² applied in the horizontal and vertical directions (in one direction at a time) to the member and any attached components (eg cladding etc.) having regard to the ultimate strength of such components and their connections. Such accidental design loading should be assumed to act simultaneously with 1/3 of all normal characteristic loading (i.e. wind and imposed loading).

Load-bearing Construction

For the purposes of this Guidance the term “load-bearing wall construction” includes masonry cross-wall construction and walls comprising close centred timber or lightweight steel section studs.

Alternative Approach

5.4 Alternatively, for any building which does not fall into the classes listed under Table 11 or for which the consequences of collapse may warrant particular examination of the risks involved, the performance may be met by the recommendations given in the following Reports:

“Guidance on Robustness and Provision against Accidental Actions” dated July, 1999, together with the accompanying BRE Report No. 200682

“Calibration of Proposed Revised Guidance on meeting Compliance with the Requirements of Building Regulation Part A3.

Both of the above documents are available on the following ODPM web-site
<http://www.odpm.gov.uk>

Diagram 25 Area at risk of collapse in the event of an accident

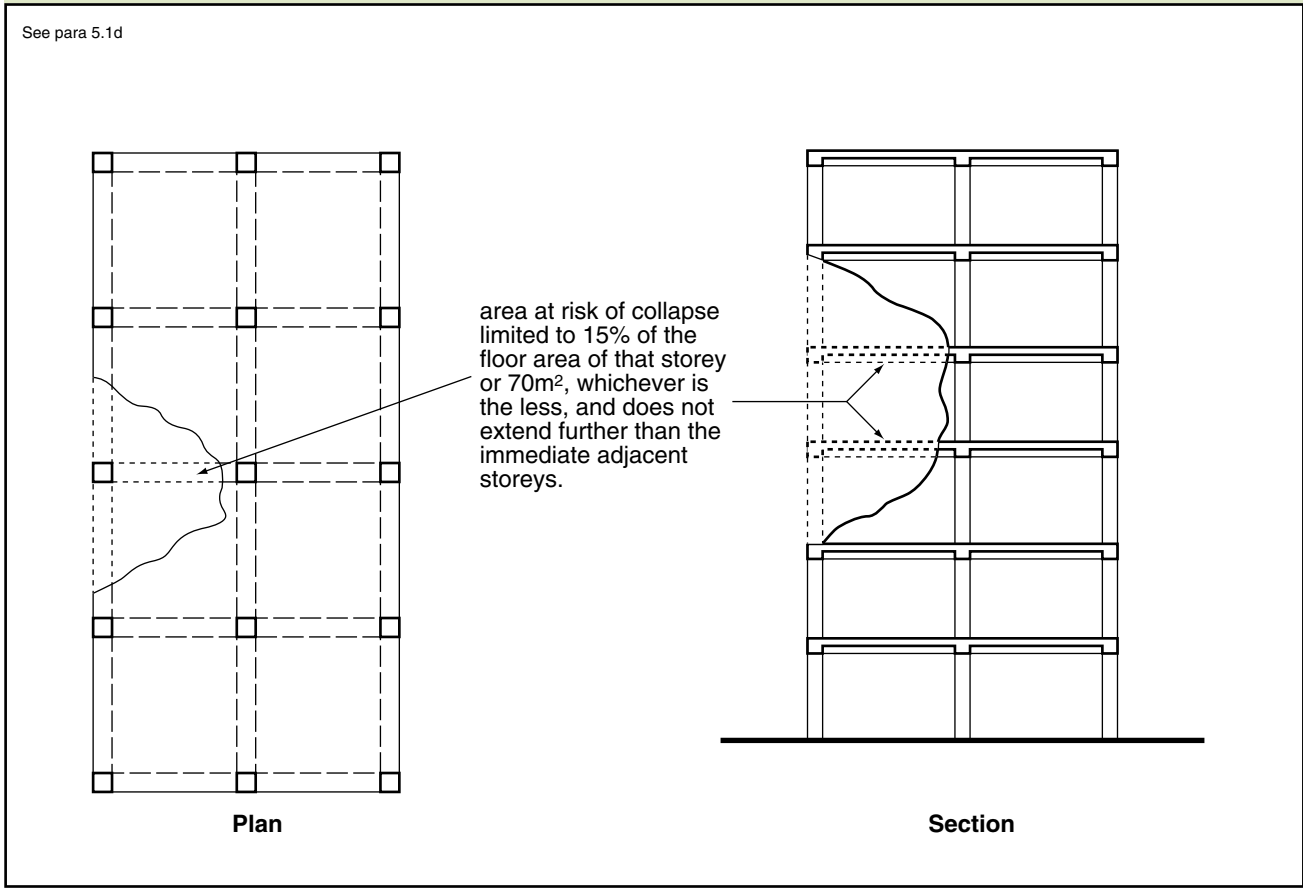

A1/2

BS 187 : 1978	Specification for calcium silicate (sandlime and flintlime) bricks	BS 6073:	Precast concrete masonry units
Amendment slip		Part 1: 1981	Specification for precast concrete masonry units
1. AMD 5427		Amendment slips	
		1. AMD 3944	
		2. AMD 4462	
BS 1243:1978	Specification for metal ties for cavity wall construction	BS 6399:	Loading for buildings :
Amendment slips		Part 1: 1996	Code of practice for dead and imposed loads
1. AMD 3651		Amendment slip	
2. AMD 4024		1. AMD 13669	
BS 3921:1985	Specification for clay bricks	BS 6399:	Loading for buildings :
Amendment slip		Part 2: 1997	Code of practice for wind loads
1. AMD 8946		Amendment slip	
BS 5080:	Structural fixings in concrete and masonry	1. AMD 13392	
Part 1 : 1993	Method of test for tensile loading	2. AMD 14009	
BS 5268:	Structural use of timber	BS 6399:	Loading for buildings
Part 2: 2002	Code of practice for permissible stress design, materials and workmanship	Part 3 :1988	Code of practice for imposed roof loads.
Part 3: 1998	Code of practice for trussed rafter roofs.	Amendment slip	
BS 5390:1976	Code of practice for stone masonry	1. AMD 6033	
Amendment slip		2. AMD 9187	
1. AMD 4272		3. AMD 9452	
BS 5628:	Code of practice for use of masonry	BS 6649: 1985	Specification for clay and calcium silicate modular bricks
Part 1: 1992	Structural use of unreinforced masonry	BS 8002: 1994	Code of practice for earth retaining structures
Amendment slip		BS 8004: 1986	Code of practice for foundations.
1. AMD 7745		Amendment slip	
2. AMD 13680		1. AMD 8851	
Part 2: 2000	Structural use of reinforced and prestressed masonry	2. AMD 12062	
Part 3: 2001	Materials and components, design and workmanship	3. AMD 13386	
BS 5950:	Structural use of steelwork in building	BS 8103:	Structural design of low-rise buildings :
Part 1: 2000	Code of practice for design. Rolled and welded sections.	Part 1: 1995	Code of practice for stability, site investigation, foundations and ground floor slabs for housing.
Amendment slip		Amendment slip	
1. AMD 13199		1. AMD 8980	
Part 2:2001	Specification for materials, fabrication and erection.	Part 2: 1996	Code of practice for masonry walls for housing
Rolled and welded sections.		Part 3: 1996	Code of practice for timber floors and roofs for housing.
Part 3 :	Design in composite construction	Part 4: 1995	Code of practice for suspended concrete floors for housing
Section 3.1: 1990	Code of practice for design of simple and continuous composite beams.	BS 8110:	Structural use of concrete
Part 4: 1994	Code of practice for design of composite slabs with profiled steel sheeting.	Part 1: 1997	Code of practice for design and construction
Part 5: 1998	Code of practice for design of cold formed thin gauge sections.	Amendment slip	
		1. AMD 9882	
		2. AMD 13468	

STANDARDS REFERRED TO

Part 2: 1985	Code of practice for special circumstances	BS EN 998	Specification for mortar for masonry
Amendment slip		Part 2 :2002	Masonry mortar
1. AMD 5914		BS EN 12620: 2002	Aggregates for concrete
2. AMD 12061		DD140-1: 1986	Method of test for mortar joint and timber frame connections
Part 3: 1995	Design charts for singly reinforced beams, doubly reinforced beams and rectangular columns.	DD140-2: 1987	Recommendations for design of wall ties
Amendment slip		A3	
1. AMD 5918		BS 5628:	Code of practice for use of masonry
BS 8118:	Structural use of aluminium	Part 1: 1992	Structural use of unreinforced masonry
Part 1: 1991	Code of practice for design	Amendment slip	
Amendment slip		1. AMD 7745	
1. AMD 10485		2. AMD 13680	
Part 2: 1991	Specification for materials, workmanship and protection	BS 5950:	Structural use of steelwork in building
Amendment slip		Part 1: 2000	Code of practice for design. Rolled and welded sections.
1. AMD 10486		Amendment slip	
BS 8297: 2000	Code of practice for design and installation of non-loadbearing precast concrete cladding.	1. AMD 13199	
Amendment slip		BS 8110:	Structural use of concrete
1. AMD 11064		Part 1: 1997	Code of practice for design and construction
2. AMD 13018		Amendment slip	
BS 8298: 1994	Code of practice for design and installation of natural stone cladding and lining	1. AMD 9882	
Amendment slip		2. AMD 13468	
1. AMD 11064		Part 2: 1985	Code of practice for special circumstances
2. AMD 13018		Amendment slip	
BS 8500:	Concrete. Complementary British Standard to BS EN 206-1	1. AMD 5914	
Part 1:2002	Method of specifying and guidance for the specifier	2. AMD 12061	
Part 2:2002	Specification for constituent materials and concrete		
BS EN 197	Cement		
Part 1:2000	Composition, specifications and conformity criteria for common elements		
Part 2:2000	Conformity evaluation		
BS EN 771	Specification for Masonry Units		
Part 1 :2003	Clay masonry units		
Part 2 :2001	Calcium silicate masonry units		
Part 3 :	Aggregate concrete masonry units [in preparation]		
Part 4 : 2001	Autoclaved aerated concrete masonry units		
Part 5 :	Manufactured stone masonry units [in preparation]		
Part 6 : 2001	Natural stone masonry units		
BS EN 845	Specification for ancillary components for masonry		
Part 1 : 2001	Ties, tension straps, hangers and brackets		
Part 2 : 2001	Lintels		
Part 3 : 2001	Bed joint reinforcement of steel meshwork		

Approved Documents

The following documents have been approved and issued by the Secretary of State for the purpose of providing practical guidance with respect to the requirements of the Building Regulations 2000 (as amended).

Approved Document A – Structure: 2004 Edition

Approved Document B – Fire safety: 2000 Edition, amended 2000 and 2002

Approved Document C – Site preparation and resistance to moisture: 1992 Edition, second impression (with amendments) 1992, further amended 2000

Approved Document D – Toxic substances: amended 1992, further amended 2000

Approved Document E – Resistance to the passage of sound: 2003 Edition

Approved Document F – Ventilation: 1995 Edition, amended 2000

Approved Document G – Hygiene: 1992 Edition, second impression (with amendments) 1992, further amended 2000

Approved Document H – Drainage and waste disposal: 2002 Edition

Approved document J – Combustion appliances and fuel storage systems: 2002 Edition

Approved Document K – Protection from falling, collision and impact: 1998 Edition, amended 2000

Approved document L1 – Conservation of fuel and power in dwellings: 2002 Edition

Approved document L2 – Conservation of fuel and power in buildings other than dwellings: 2002 Edition

Approved Document M – Access and facilities for disabled people: 2004 Edition

Approved Document N – Glazing - safety in relation to impact, opening and cleaning: 1998 Edition, amended 2000

Approved Document to support regulation 7 – materials and workmanship: 1999 Edition, amended 2000

Published by TSO (The Stationery Office) and available from:

Online

www.tso.co.uk/bookshop

Mail, Telephone, Fax & E-mail

TSO

PO Box 29, Norwich NR3 1GN

Telephone orders/General enquiries: 0870 600 5522

Fax orders: 0870 600 5533

E-mail: book.orders@tso.co.uk

Textphone: 0870 240 3701

TSO Shops

123 Kingsway, London WC2B 6PQ

020 7242 6393 Fax 020 7242 6394

68–69 Bull Street, Birmingham B4 6AD

0121 236 9696 Fax 0121 236 9699

9–21 Princess Street, Manchester M60 8AS

0161 834 7201 Fax 0161 833 0634

16 Arthur Street, Belfast BT1 4GD

028 9023 8451 Fax 028 9023 5401

18–19, High Street, Cardiff CF10 1PT

029 2039 5548 Fax 029 2038 4347

71 Lothian Road, Edinburgh EH3 9AZ

0870 606 5566 Fax 0870 606 5588

TSO Accredited Agents

(see Yellow Pages)

and through good booksellers

© Crown Copyright 2004.

Copyright in the typographical arrangement and design rests with the Crown.

Published for the Office of the Deputy Prime Minister, under licence from the Controller of Her Majesty's Stationery Office.

This publication, excluding logos, may be reproduced free of charge in any format or medium for research, private study or for internal circulation within an organisation. This is subject to it being reproduced accurately and not used in a misleading context. The material must be acknowledged as Crown copyright and the title of the publication specified.

For any other use of this material please write to The HMSO Licensing Division, HMSO, St Clements House, 2–16 Colegate, Norwich NR3 1BQ.
Fax: 01603 723000 or email: licensing@cabinet-office.x.gsi.gov.uk

£11



www.tso.co.uk

ISBN 0-11-753909-0

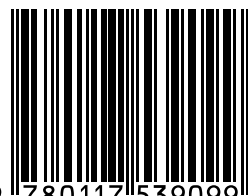

9 780117 539099 >

