

# Controls for domestic central heating and hot water

– guidance for specifiers and installers



- Controls for central heating systems with boilers and radiators, warm air units, or electric storage heaters
- How controls can reduce energy consumption
- The 'minimum set' of controls and 'best practice'



HOUSING  
ENERGY EFFICIENCY

BEST PRACTICE  
PROGRAMME



## CONTENTS

<b>1</b>	<b>INTRODUCTION</b>	<b>4</b>
<b>2</b>	<b>INDIVIDUAL CONTROLS</b>	<b>6</b>
<b>3</b>	<b>SELECTION OF CONTROLS</b>	<b>10</b>
<b>4</b>	<b>UPGRADING SYSTEMS</b>	<b>16</b>
<b>5</b>	<b>INSTALLING CONTROLS</b>	<b>17</b>
<b>6</b>	<b>COMMISSIONING</b>	<b>19</b>
<b>7</b>	<b>ENERGY SAVINGS</b>	<b>19</b>
<b>8</b>	<b>ADVICE TO HOUSEHOLDERS</b>	<b>21</b>
	<b>APPENDIX – DEFINITIONS OF CONTROLS</b>	<b>21</b>
	<b>REFERENCES AND FURTHER READING</b>	<b>24</b>

For specific installation guidance, reference should always be made to manufacturers' instructions. Reference should also be made to Building Regulations, standards and codes of practice.

This Guide is based on material drafted by Advantica Technologies Ltd under contract to BRECSU for the Energy Efficiency Best Practice programme.

The following organisations were consulted during the preparation of this Guide:



## 1 INTRODUCTION

The installation of effective controls has a major impact on the energy consumption of heating and hot water systems. This Guide brings together information on the individual types of controls that are now available and the most appropriate controls suitable for different heating systems. It provides information to assist installers and specifiers to make the best choices in the selection of controls, which will lead to:

- improved energy efficiency
- reduced running costs
- lower carbon dioxide (CO<sub>2</sub>) emissions.

The Guide covers controls for all domestic central heating systems supplied by mains gas, liquefied petroleum gas (LPG), oil, electricity and solid fuel.

Effective controls will increase operating efficiency, particularly when updating older systems, but they also provide the householder with the opportunity to minimise energy consumption by reducing comfort temperatures. Timed heating and hot water periods can also reduce overheating. Heating fuel is expensive (gas boilers and warm air heaters typically cost 15-35p/hour when they are operating) and reducing the firing time will make a proportionate difference to running costs.

The provision of a minimum standard of controls is crucial to the achievement of satisfactory in-use efficiencies for 'wet' heating systems (those with a boiler and radiators). Requirements for minimum boiler efficiency based on SEDBUK – Seasonal Efficiency of Domestic Boilers in the UK – will be introduced in revised Building Regulations in 2002. The minimum set of controls recommended in this Guide must be installed to achieve SEDBUK efficiency. A number of Government-backed energy efficiency schemes are being introduced, eg HEES plus (Home Energy Efficiency Scheme) where these minimum standards of controls are specified.

What is a 'good' control system? It will ensure that the boiler or heater does not operate unless there is a demand, and it must only provide heat when and where it is required, so as to achieve the required temperatures. The selection of appropriate controls

### HOW TO USE THIS GUIDE

- Section 2 describes what the individual controls do and their particular benefits.
- Section 3 provides help on selecting controls and the minimum set that should be used to meet the requirements of the Building Regulations.
- Section 4 deals with upgrading existing systems.
- Section 5 provides advice on installation.
- Section 6 outlines commissioning of controls.
- Section 7 outlines energy-saving benefits.
- Section 8 gives advice to householders.
- The appendix gives definitions of various types of controls.

### THE STANDARD ASSESSMENT PROCEDURE (SAP) AND BUILDING REGULATIONS

This Guide provides a recommended minimum set of controls that are expected to meet the new requirements of the Building Regulations 2002 (not yet published)<sup>[1,2,3]</sup>.

### VAT ON HEATING CONTROLS

Heating controls for domestic wet central heating systems are recognised as an energy efficiency measure, and VAT is charged at a lower rate – currently 5% instead of 17.5%. The lower rate applies to both the equipment and installation costs, but only when the work is done by an installer registered for VAT.

plays a key part in the overall running costs of a heating or hot water system.

The cost benefits of controls should not be underestimated. Upgrading controls on older heating systems can save up to 17% on energy bills, for example when a full set of controls are fitted to a system which previously had none. This is particularly important because over 80% of the energy a householder uses in the home

## INTRODUCTION

is for heating and hot water and the use of controls will directly influence this consumption. Also, over 50% of the household energy costs and 65% of the CO<sub>2</sub> emissions come from providing space and water heating in the home.

This Guide describes controls for boiler ('wet') systems, warm air systems, electric storage heating and hot water systems. It provides advice on good practice and considers both new systems and upgrading. More advanced control functions, such as weather compensators and optimum start, are also considered.

The Guide provides information on controls for domestic heating and hot water systems up to a heat output of 50 kW. For larger systems, it may be that more sophisticated controls can be justified – guidance on controls for small commercial buildings is given in Good Practice Guide (GPG) 132<sup>[4]</sup>. More general guidance on domestic central heating and hot water with gas and oil-fired boilers is given in GPG 284<sup>[5]</sup>.

This Guide is published as part of the Government's Energy Efficiency Best Practice programme (EEBPP), the building-related aspects of which are managed by BRECSU.

#### WHICH SYSTEMS BENEFIT FROM CENTRAL HEATING CONTROLS?



- **'Wet' systems** – with radiators, convectors or underfloor heating:
  - regular boiler systems – separate hot water tank
  - combi boiler systems – instantaneous, or 'built-in' tank.
- **Warm air systems.**
- **Electric storage and panel systems** – space and water heating using on-peak and off-peak electricity.

#### ENERGY SAVINGS FROM GOOD CONTROLS

- Heating and hot water accounts for over 80% of the energy consumption in the home.
- The installation of a minimum standard of controls in a wet system (which previously had no controls) can reduce fuel consumption and CO<sub>2</sub> emissions by 17%.
- Controls to reduce higher-than-necessary room temperatures are very beneficial. Turning down the room thermostat by 1°C will reduce space heating consumption by 6-10%.
- Reducing the heating 'on' time by two hours a day can reduce consumption by 6%.

## 2 INDIVIDUAL CONTROLS

This section explains the range of controls that are commonly available, what they do and why they are important. Controls for wet, warm air and electric storage systems are described. These controls are normally fitted away from the heating appliance, although some controls are integral with the appliance, and they are described in later sections. For clarity of specification, the appendix (page 21) contains a full list of controls, including those often fitted within appliances, with industry-agreed definitions.

Typically used in:	
	Wet systems
	Warm air systems
	Electric storage systems

### TIME SWITCH



Simple time control of a system that will only switch one circuit. Most suitable for combis. Should be chosen so that it is easy to understand and use, especially when there is a change to the householder's domestic routine.



### PROGRAMMER

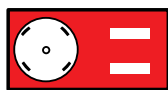

A programmer can switch two circuits separately (usually heating and hot water). There are three basic types:

- a **mini-programmer** allows space heating and hot water to be on together, or hot water alone, but not heating alone
- a **standard programmer** uses the same time settings for space heating and hot water



- a **full programmer** allows the time settings for space heating and hot water to be fully independent.

### ROOM THERMOSTAT



Simple room temperature control. Most room thermostats include an accelerator (or anticipator), which has the effect of smoothing out the temperature cycle, so that on and off periods are not too long. Wireless units are now available that provide increased flexibility in positioning and eliminate visible wiring. (See note on page 12 concerning 'Radiomark'<sup>[6]</sup>.)



### PROGRAMMABLE ROOM THERMOSTAT



Allows different temperatures to be set for different periods in the day or week. Provides a better match to the householder living pattern. Important if occupancy is varied over the day or week. Provides a 'night setback feature' where a minimum temperature can be maintained at night. Many are battery operated and can replace a conventional thermostat without the need for additional cabling. Some also allow time control of hot water.

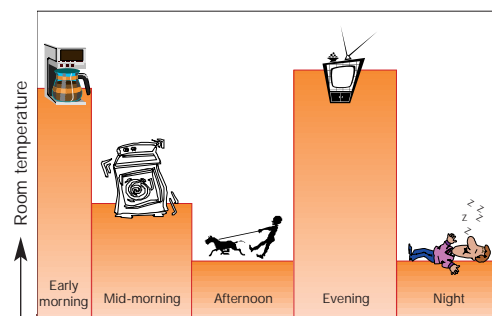

**Figure 1** A programmable room thermostat, with its greater flexibility in setting temperatures and times, has the capability to provide greater savings than a 'standard' room thermostat

INDIVIDUAL CONTROLS

CYLINDER THERMOSTAT



Simple control of stored hot water temperature, usually strapped to the side of the hot water cylinder. It is commonly used with a motorised valve to provide close control of water temperature.



FROST THERMOSTAT



Simple override control used to avoid frost damage to the dwelling and/or boiler and system. A frost air thermostat should be fitted in a suitable place inside the dwelling so that a minimum temperature is always maintained.



PIPE THERMOSTAT

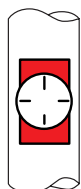

Where the boiler is fitted in an unheated area, for example a garage, a pipe thermostat should also be fitted (to the exposed pipework). This pipe thermostat is in addition to a frost air thermostat to prevent the boiler firing unnecessarily in cold weather and wasting fuel.



THERMOSTATIC RADIATOR VALVE



Used to limit temperatures in individual rooms and so reduce energy consumption. Provides an upper limit to room temperatures and so can usefully prevent overheating due to solar and incidental gains.



THERMOSTATIC HOT WATER TEMPERATURE LIMIT VALVE

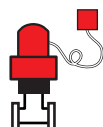

Self-acting valves without motors that are used to limit hot water temperature in domestic hot water cylinders. Units are available that sense the primary water (boiler) temperature and also with a separate remote sensor that can sense stored water temperature. Cylinder controls should not be used unless they also operate an electrical switch to provide boiler interlock, otherwise the boiler will cycle unnecessarily.



MOTORISED VALVE



Used to control water flow from boiler to heating and hot water circuits. Two-port valves can also be used to provide zone control, eg lower temperatures in sleeping area or different heating times. See 'Definitions of controls' on page 22 for an explanation of different types.



## INDIVIDUAL CONTROLS

### BOILER INTERLOCK



This is not a control device but a wiring arrangement to prevent the boiler firing when there is no demand for heat. The boiler can be said to be 'interlocked' when the boiler is switched 'on' and 'off' by the operation of a room or cylinder thermostat (or a boiler energy manager). In many cases the interlock will also apply to the pump operation but any requirements for pump overrun must be observed. Without an interlock, the boiler is likely to cycle on and off regularly and waste energy by keeping the boiler hot when it is not necessary.

For regular boiler systems, the interlock is usually arranged so that the room or cylinder thermostat switches the power supply to the boiler (and sometimes the pump) through the motorised valve 'end' switches. For combi boilers interlock is usually achieved by using a room thermostat.

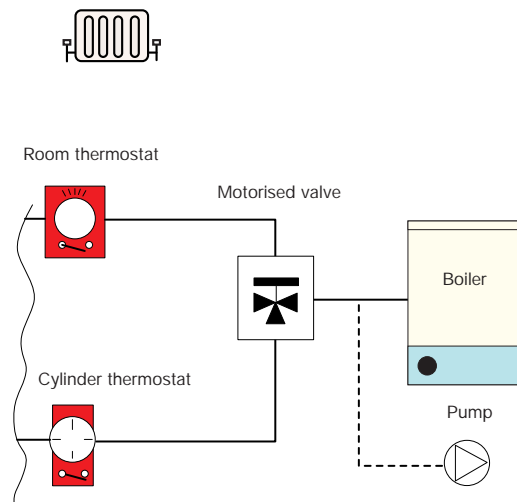
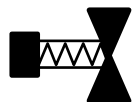

Figure 2 Boiler interlock - through motorised valve

### AUTOMATIC BYPASS VALVE



This device controls water flow in accordance with the water pressure across it, and is used to maintain a minimum flow rate through the boiler and to limit circulation pressure when alternative water paths are closed. A bypass circuit must be installed if the boiler manufacturer requires one, or specifies that a minimum flow rate has to be maintained while the boiler is firing. The installed bypass circuit must then include an automatic bypass valve (not a fixed position valve).

The use of an automatic bypass is important where the system includes a large number of thermostatic radiator valves (TRVs). When most TRVs are open, the automatic bypass remains closed, allowing the full water flow to circulate around the heating



system. As the TRVs start to close, the automatic bypass starts to open, maintaining the appropriate water flow through the boiler. The use of an automatic bypass is also likely to reduce noise in the system due to excess water velocity.

An automatic bypass is always preferable to a fixed bypass. With a fixed bypass there is a constant flow of hot water coming out of the boiler, which is fed directly into the return at all times. This allows the boiler to operate at a higher temperature, which reduces efficiency and restricts the amount of heat transferred to the system.

### HOT WATER CONTROLLER



Time control for on/off-peak electricity use, which ensures that the water is heated using electricity during off-peak periods. This time control is not usually accessible to the user. The control also frequently provides a separate boost control (usually one or two hours) so that a smaller quantity of water can be heated during the day but using more expensive on-peak electricity.





## INDIVIDUAL CONTROLS

### BOILER ENERGY MANAGER



These controls are self-contained devices that include a number of the functions described in this section. They usually include weather or load compensation and sometimes also optimum start, frost protection, night setback, anti-cycling control and hot water control.



### 'CELECT-TYPE' ELECTRIC HEATING CONTROL



Integrated central control system for electric storage and panel heaters that provides programmed space temperatures at different times of the day for a number of separate heating zones in the dwelling. It minimises the charge period of the storage heaters according to weather and also controls the switching of the panel heaters.



### CONTROL 'FUNCTIONS'

The following control functions are often built into units.

#### Compensator

Reduces boiler water temperature for space heating according to internal/external air temperature and should increase the efficiency of condensing boilers by reducing the average return water temperature of the system.



#### Delayed start

Reduces energy use by delaying boiler start time when the weather is mild.



#### Optimum start

Adjusts the heating start time to give the required dwelling comfort temperature at a chosen time.



#### Night setback

Allows a low temperature to be maintained at night. Provides improved comfort and reduced dwelling warm-up time in cold weather. A programmable room thermostat can provide this facility.



#### Self-adaptive function

Reduces appliance 'on' time by learning from previous temperature characteristics.



#### Anti-cycling control

Delays boiler firing to reduce cycling frequency but is unlikely to provide significant energy savings<sup>[7]</sup>. In some circumstances their use may reduce energy consumption, but usually at the expense of performance or comfort. Standalone units (those not supplied as part of the boiler) are not generally recommended as they provide little or no improvement over the minimum level of control shown in this Guide.



### 3 SELECTION OF CONTROLS

This section provides information on the recommended options for controls used in wet systems, warm air systems and electric storage systems.

#### WET SYSTEMS – CENTRAL HEATING SYSTEM SPECIFICATIONS

To help purchasers to specify efficient wet systems, a set of simple system specifications for current good practice and best practice has been published by the Government's EEBPP in General Information Leaflet (GIL) 59 'Central Heating System Specifications (CHeSS) – year 2000' [8]. The specifications are used to specify the main components (boilers, hot water stores, controls) that are critical to energy efficiency. The controls included in these specifications are set out below. There are two levels:

- the **minimum set** of controls to achieve good energy efficiency performance and compliance with the requirements of the Building Regulations (2001) – CHeSS, HR1 and HC1 (note that the term 'good practice' is used in CHeSS – this is equivalent to 'minimum set' as used in this Guide)
- **best practice** provide enhanced standards to further improve the controllability and energy efficiency of the system – CHeSS HR2 and HC2.

The recommendations apply specifically to gas (including LPG) and oil-fired heating systems. Further guidance for solid fuel systems is given on page 14.

Particular care should be taken when choosing controls for use by the elderly and infirm to ensure ease of use, clarity of function and indication.

New wet systems must always be fully pumped, and it is recommended that existing semi-gravity systems (gravity circulation to the hot water cylinder) are converted to fully pumped. Published boiler efficiencies (SEDBUK\*) cannot be achieved unless the system is fully pumped and adequately controlled.

\* SEDBUK (Seasonal Efficiency of Domestic Boilers in the UK<sup>[9]</sup>) is the average annual in-use efficiency applicable to a particular boiler and makes reasonable assumptions about pattern of usage, climate, control and other influences. It is calculated from the results of standard laboratory tests with other important factors such as boiler type, burner type, ignition arrangement, internal store size and fuel used.

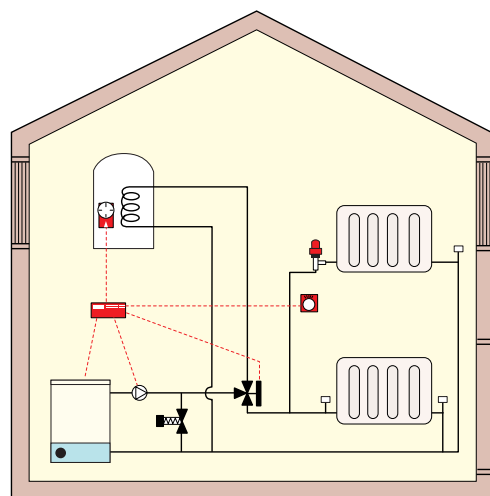

#### System controls







-  Room thermostat
-  Time switch/programmer
-  Cylinder thermostat
-  Motorised valve
-  Thermostatic radiator valve (TRV)
-  Automatic bypass valve

Figure 3 Typical 'wet' system

SELECTION OF CONTROLS

**BEST PRACTICE – COMBI BOILERS**

- Programmable room thermostat
- TRVs on all radiators except in rooms with a room thermostat
- Automatic bypass valve (see page 8)

**MINIMUM SET – COMBI BOILERS**

- Time switch
- Room thermostat
- TRVs on all radiators except in rooms with a room thermostat
- Automatic bypass valve (see page 8)

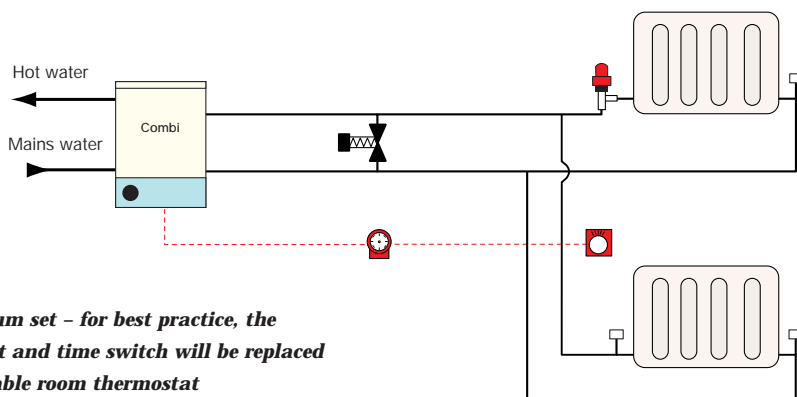

*Figure 4 Minimum set – for best practice, the room thermostat and time switch will be replaced by a programmable room thermostat*

**BEST PRACTICE – REGULAR BOILERS**

- Programmable room thermostat with additional hot water timing capability
- Cylinder thermostat
- TRVs on all radiators except in rooms with a room thermostat
- Automatic bypass valve (see page 8)

**MINIMUM SET – REGULAR BOILERS**

- Room thermostat
- Full programmer
- Cylinder thermostat
- TRVs on all radiators except in rooms with a room thermostat
- Automatic bypass valve (see page 8)

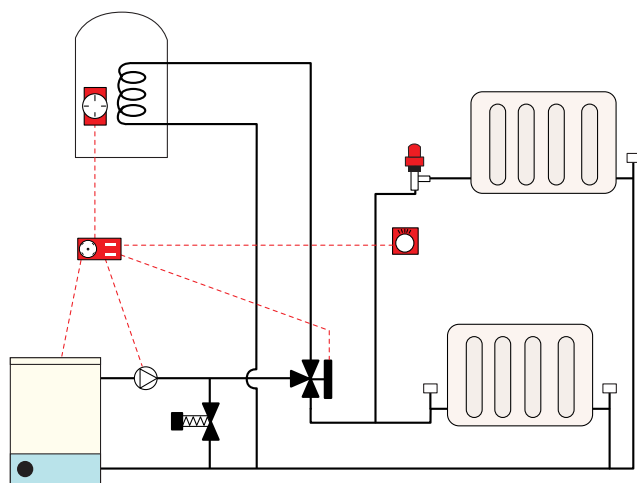

*Figure 5 Minimum set – for best practice, room thermostat and programmer will be replaced by a programmable room thermostat with additional hot water timing capability*

## SELECTION OF CONTROLS

---

### USING MINIMUM SET AND BEST PRACTICE CONTROLS

- Systems with regular boilers must have separately controlled circuits to the hot water cylinder and radiators, and both circuits must have pumped circulation.
- Room thermostats, programmable room thermostats, cylinder thermostats, programmers and time switches must be wired so that they are interlocked with the boiler and pump, ie they prevent the boiler from firing when there is no demand for heat.
- A bypass circuit must be installed if the boiler manufacturer specifies that a minimum flow rate has to be maintained while the boiler is firing. The installed bypass circuit must then include an automatic bypass valve (not a fixed position valve).
- Frost protection must be provided where necessary to protect the appliance, system and dwelling.
- Radiators in rooms with a controlling room thermostat should be fitted with lock-shield valves on both inlet and outlet connections.
- Wireless controls should be designed with a satisfactory level of immunity to interference, as nearby frequency bands will become increasingly heavily used. Compliance with EU essential requirements is not sufficient to ensure that the transmitter-receiver pair will work correctly in the presence of other signals. Products bearing the Radiomark symbol have been certified to meet this requirement concerning quality and fitness for purpose (see box).

### RADIOMARK

Wireless controls should be designed with a satisfactory level of immunity to blocking by other radio transmissions. Otherwise they may become unreliable, or cease to work, as nearby radio frequency bands become increasingly heavily used from year 2002 onwards. Products bearing the new Radiomark symbol have been certified to meet this requirement concerning quality, fitness for purpose, and traceability (see website [www.radiomark.org](http://www.radiomark.org)).

For products not bearing the Radiomark, the manufacturer should confirm that the switching range (and preferably alignment range) do not include any frequencies below 430 MHz, and that in regard to ETSI EN 300 220-1 v1.3.1<sup>[10]</sup> the receiver classification (clause 4.1.1) is either Class 1 or Class 2, and the device is marked in accordance with clause 4.3.4. Compliance with the essential requirements under article 3.2 of the EC Radio & Telecommunications Terminal Equipment Directive 1999/5/EC is not sufficient, as the directive is designed only to ensure that wireless products do not cause harmful interference to other transmissions.

## SELECTION OF CONTROLS

### FURTHER IMPROVEMENTS – WET SYSTEMS

#### Zone control

The minimum set and best practice options already include zone temperature control using TRVs. Another option is to provide an additional room thermostat and a two-port motorised valve for part of the radiator circuit (eg upstairs rooms). This provides a separate zone with the opportunity for separate time and temperature control. This is particularly beneficial in larger, poorly insulated dwellings.

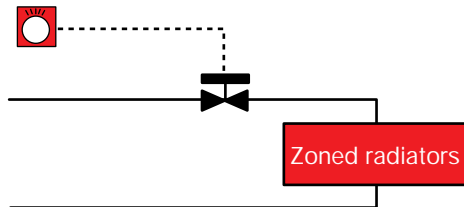

Figure 6 Zone controls

#### Weather compensating function

To reduce average water circulation temperature as external temperatures rise. The greatest benefit is achieved where condensing boilers are used.

#### Delayed start/optimum start function

Heat-up times are reduced during mild weather, which saves energy. Delayed start will only reduce heat-up times. An optimum start control is designed to ensure the dwelling only reaches its desired temperature when the householder requires it.

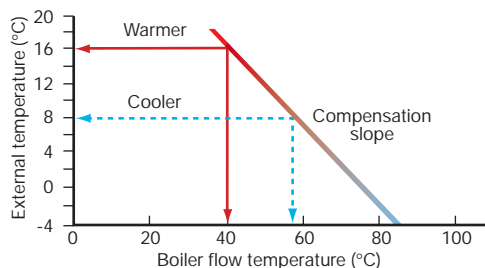

Figure 7 Weather compensation

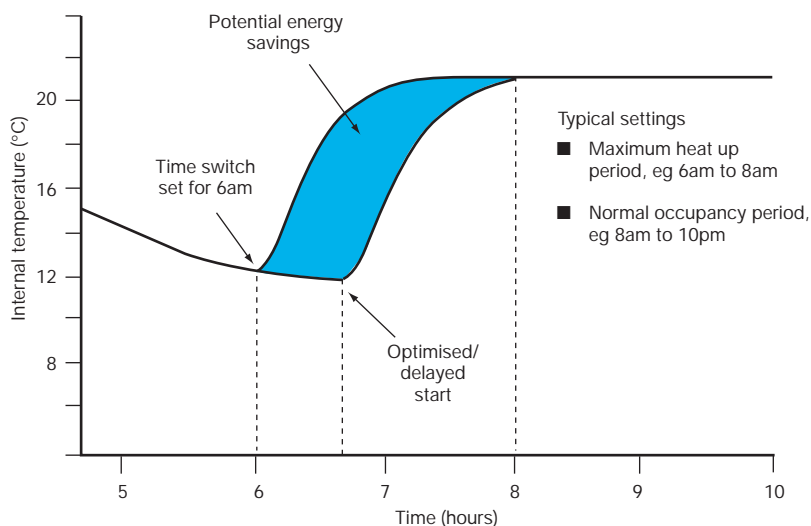

Figure 8 Delayed start/optimum start function

## SELECTION OF CONTROLS



### SOLID FUEL BOILER SYSTEMS

Modern central heating controls can be used with systems fired by solid fuel, but particular care must be taken to ensure that the safety of the system is not compromised. This includes ensuring that there is always a suitable heat bleed (sometimes called slumber circuit) from the system, for example a gravity-fed radiator or hot water cylinder that is always connected to the system independent of any controls.

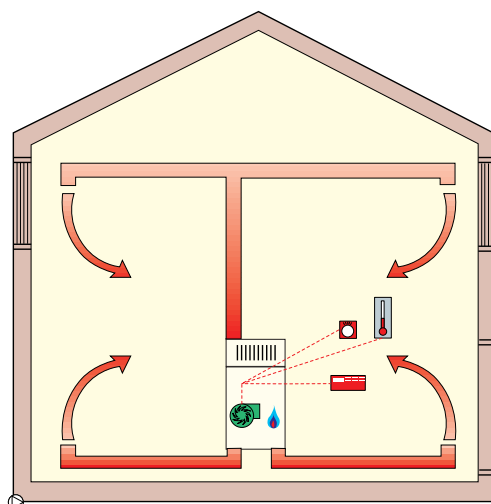
Most solid fuel boilers are thermostatically controlled. A thermostat can vary the amount of air provided to the fire and so adjust the rate at which fuel can be burned, but the combustion cannot be completely stopped and so some heat will be produced whenever the fire is lit. A room thermostat and time switch or programmable room thermostat can be used to



#### System controls

-  Room thermostat
-  Time switch/programmer
-  Room temperature sensor

#### Appliance controls

-  Heater firing/fan speed control

Figure 9 Warm air space heating

control the pump so that the user can control comfort temperature as required. Also, TRVs can be used on individual radiators but it is recommended that at least two radiators do not have TRVs to ensure that when the fire is lit any heat being produced can be put to good use and cannot cause boiling in the system. Further advice on system design for solid fuel systems can be obtained from the Solid Fuel Association<sup>[11]</sup>.

### WARM AIR SYSTEMS

The controls for warm air systems are simple compared with wet systems. Examples of warm air system controls are:

- controls external to heater
  - time switch/programmer
  - room thermostat (standard or programmable)
- controls integrated with heater
  - integrated programmer
  - room temperature sensor linked to heater firing and fan speed control (normally referred to as 'gas-air modulation').

#### Best practice - warm air systems

Use warm air systems that incorporate integrated controls to ensure that the fan speed is varied to match the firing cycle of the burner. These controls reduce variations in room temperature so improving comfort, economy and noise levels.

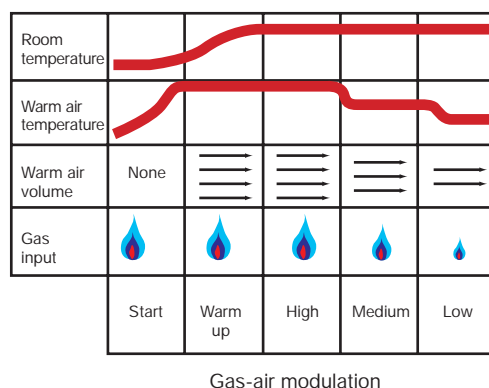

Figure 10 Effect of gas-air modulation on the operation of a warm-air heater

## SELECTION OF CONTROLS

### ELECTRIC STORAGE SYSTEMS

Electric storage systems work by ‘charging’ a brick store with heat when electricity is cheap, and ‘discharging’ it during the day. The controls for electric storage systems are usually integrated with appliances.

#### Controls integrated with appliances

- Storage heater – manual charge control
- Storage heater – automatic charge control
- Storage heater – heat output control using damper or use of fan (where fitted)
- Time switch and thermostat on direct-acting panel heaters
- CELECT-type integrated controls

Automatic charge control is usually provided by a sensor within the heater that adjusts the electrical input to the heater. Once set it operates automatically and does not require further manual adjustment. The sensor will detect when room temperature is high and so reduce the charge; similarly, when room temperature is low it will increase the charge. Automatic charge control is preferable to manual adjustment and can reduce running costs. Heat output control is provided using a damper or fan. The householder can adjust this to reduce overheating to the room.

#### Best practice – electric storage systems

Use of CELECT-type integrated system controls. The main controller used in this type of system has electronic sensors fitted in the main rooms of the dwelling and these are linked to a central control device. It monitors the individual room sensors, and optimises the charging of all storage heaters individually. It will also switch on direct acting heaters where necessary. This allows separate time and temperature control in all system zones.

### ELECTRIC WATER HEATING

Purpose-designed hot water storage cylinders for use with off-peak tariff electricity usually have two immersion heaters installed. One is located at the bottom of the cylinder and is operated by the off-peak time switch, the other is located near the top of the cylinder and is controlled by the boost timer.

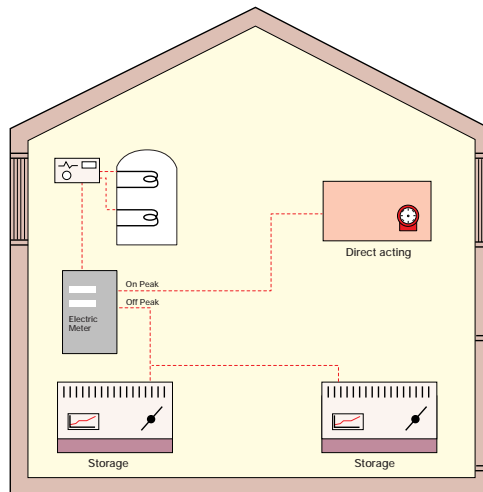

#### System controls

Hot water control

Time switch

#### Appliance controls

Heat input (charge) control

Heat output control

**Figure 11** Electric space- and water-heating system

Each heater has its own integral thermostat.

The boost immersion heater is near the top of the cylinder to ensure that only a limited amount of water will be heated using on-peak electricity.

The off-peak thermostat is usually set at 65°C and the boost at 60°C. Top-entry immersion heaters are also available that include dual immersion elements – short for on-peak and long for off-peak.

The on/off-peak hot water control should include a time switch and on-peak boost timer.

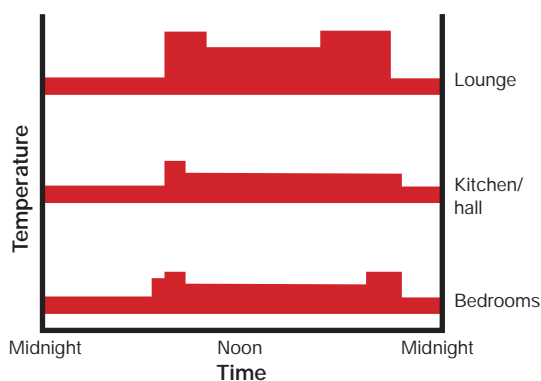

**Figure 12** Typical time/temperature profile in three zones using a CELECT-type system

## 4 UPGRADING SYSTEMS

### WET SYSTEMS

Many existing wet central heating systems are of obsolete design and are poorly controlled.

Poor design features that should be improved are:

- gravity circulation to the hot water cylinder – stored water is slow to re-heat
- no cylinder thermostat – excessive stored hot water temperatures
- no room thermostat – excessive room temperatures
- no boiler interlock – boiler keeps hot unnecessarily during programmed periods of heating and hot water.

Where possible always upgrade at least to the minimum set of controls. Where it is not possible to convert to full pumping, the following system will provide many of the energy efficiency benefits:

- cylinder thermostat
- room thermostat (or programmable room thermostat)
- standard programmer (or programmable room thermostat)
- one two-port motorised valve fitted on the gravity flow to the hot water cylinder
- TRVs on all radiators except in rooms with a room thermostat
- boiler interlock.

### WARM AIR SYSTEMS

The main benefits of improved controls for warm air systems are gained when the air heater is replaced. Most modern air heaters include controls that vary the firing rate as well as controlling the air fan speed, which reduces noise and provides a more even temperature.

### ELECTRIC STORAGE HEATING SYSTEMS

The options for upgrading the controls used with existing electric storage heating systems are limited, because the improved controls are usually integral to the appliances or designed specifically for use in modern appliances. However, an external temperature sensor can be fitted that adjusts the charge taken in accordance with external temperature.

It is not practical to update controls used with older-type storage heaters. Replacement of the system with the integrated CELECT-type system (see page 9) can be considered. Significant running cost benefits are possible using modern storage heaters, which have improved integral controls such as automatic charge control and/or fan/damper controls.

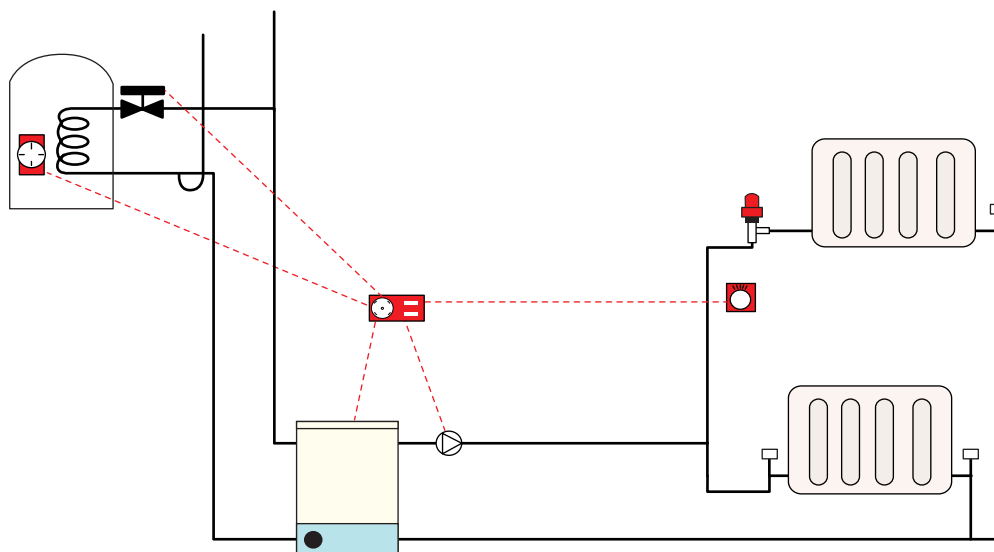

Figure 13 Upgraded system retaining gravity domestic hot water



## 5 INSTALLING CONTROLS

## TIME SWITCH/PROGRAMMER



Ensure that the unit is suitable, because time switches can only switch one circuit (eg heating for combi boilers). Programmers can switch two circuits (eg heating and hot water). They should be installed so they can be read and easily reached

and altered. Do not install in positions that are inconvenient for the householder (eg in an airing cupboard).

## ROOM THERMOSTAT



A room thermostat should be sited in a regularly heated area that allows free circulation around it. It should not be exposed to draughts, and should be away from internal heat sources and direct sunlight. It should also be in a position that is readily accessible to the householder, eg not in cupboards or behind furniture.

The thermostat should be sited about 1.5 m above floor level, except where the occupants include a wheelchair user. In this case a suitable height in

excess of 1 m should be agreed with the householder. The room thermostat should not be sited where supplementary room heating (eg gas, electric, solid fuel fire) will affect it. Appropriate positions will be in the hall or other living room (ie without supplementary heating). It should not be sited in a kitchen or combined kitchen/dining room and should only be sited in a main living room where it is certain that supplementary heating is not used.

## CYLINDER THERMOSTAT



This usually straps onto the cylinder at a height of about one-third up from its base – the strap should be tight for good thermal contact. It should be adjusted to around 60°C. If set too high it may give rise to scalding, and if set too low it will

increase risk of the growth of legionella bacteria, which could lead to serious health problems<sup>[12,13]</sup>.

## MOTORISED VALVE



Two- and three-port valves are most commonly used and installation depends on pipework layout and preference. For example:

- three-port valves are suitable for providing separate heating and hot water circuits; most three-port valves provide a mid-position so that shared flow is possible
- for more than one heating zone, in addition to a hot water zone, use a separate two-port valve for each zone

- 22 mm valves are usually suitable for boilers up to around 20 kW; for larger boilers, and when fitting a motorised valve on a gravity hot water circuit, 28 mm or larger should be used
- the motorised valve is not to be positioned in the line of the open safety vent pipe or feed and expansion pipe.

## THERMOSTATIC RADIATOR VALVE

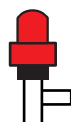

They should be installed together with a room thermostat to provide boiler interlock. Many TRVs can now be installed in either the flow or return to the radiator and many modern ones are bi-directional – if not, it is necessary to ensure that the water flow is in the correct direction. If more

than half of the radiators in a dwelling are fitted with TRVs, an automatic bypass will usually be necessary (see page 8).

## INSTALLING CONTROLS

---

### AUTOMATIC BYPASS VALVE

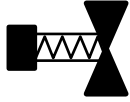

The valve should be installed between the boiler primary flow and return, noting the direction of flow. Ensure that the valve has adequate flow capacity. It should be set correctly so as to ensure adequate flow rate through the boiler when all motorised valves and/or TRVs close.

### FROST PROTECTION (AIR AND PIPE THERMOSTAT)



Where both air and pipe thermostats are used, the contacts should be wired in series from a live supply that is not switched by time switch/ programmer or thermostats, ie protection needs to be available 24 hours a day. Note that some boilers

already include their own frost protection, but it should be checked to confirm that the dwelling is still adequately protected.

### WEATHER COMPENSATOR OR UNIT WITH EXTERNAL SENSOR

Where a unit includes an external sensor it is important to position the sensor on a north-facing wall, out of direct sunlight and away from other heat sources.

## 6 COMMISSIONING

---

If a heating and hot water system is to operate as intended and with optimum energy efficiency it must be effectively commissioned. This is especially relevant for controls since they must operate effectively over a wide range of usage and climatic conditions. Following the introduction of revised Building Regulations (part L) in 2002, it will become a mandatory requirement that all systems are satisfactorily commissioned.

All controls should be installed and commissioned in accordance with manufacturers' instructions. Care must be taken to install the wiring correctly,

and a test should be carried out to make sure that the boiler interlock operates (ie the boiler switches off when there is no demand for heat). The heat emitter and hot water flow rates should be balanced, and the automatic bypass valve set correctly. All TRVs and thermostats must be adjusted to meet householder requirements, and the householder informed of any settings that should be changed between summer and winter.

## 7 ENERGY SAVINGS

---

An important aim of this Guide is to provide information that will lead to improved energy efficiency and reduced CO<sub>2</sub> emissions. The use of controls will have an impact on energy use in two different ways:

- reducing heating requirements
- increasing heating and hot water system efficiency.

Reducing heating requirements has by far the biggest impact on energy consumption. This can be achieved by reducing the heating 'on' time and 'set' temperature. It is important to ensure that suitable controls are

specified that give the householder the opportunity to adjust the controls to minimise energy demand. Some controls will also increase the efficiency of the system. For modern boilers fitted with the minimum set of controls, this effect will not be large.

### **RUNNING COSTS AND COMFORT CONTROL**

One of the most effective ways to save energy is to turn the heating down or off! Typically, a room thermostat fitted in the main living room would be set to around 21°C. If this is reduced to 20°C, heating energy consumption can be reduced by 6-10%.

ENERGY SAVINGS

Existing system has the following controls	Improved system: add the following <sup>1</sup> for the 'minimum set'	Approximate average savings <sup>2</sup> (% of the existing fuel consumption)	Typical average annual fuel cost savings £ <sup>2</sup>		
			Terraced	Semi-detached	Detached
<b>Typical boiler with gravity DHW</b>					
		17%	51	58	82
		12%	36	41	58
<sup>3</sup>		11%	33	38	53
		4%	11	13	18
		9%	27	31	44
<b>Typical boiler – fully pumped<sup>4</sup></b>					
		17%	51	58	82
		10%	30	34	48
		4%	11	13	18
		9%	27	31	44
<b>Typical combi boiler<sup>4</sup></b>					
		15%	45	52	73
		7%	21	24	34
		4%	11	13	18

NOTES

- 1 All improved systems should include a programmer (regular boiler) or time switch (combi boiler).
- 2 These are average savings assuming normal controls, systems and user behaviour. Actual savings in individual systems may be significantly different. It is assumed that the SEDBUK (see page 10) is 68% (ie with the minimum set of controls fitted).
- 3 This option provides only a partial boiler interlock (hot water only).
- 4 Improved systems should include an automatic bypass valve if a bypass circuit is necessary (see page 8).

Table 1 Potential average savings<sup>2</sup> with improved controls fitted to systems with older-type boilers

KEY

- Room thermostat
- Cylinder thermostat
- Motorised valve(s)
- Boiler interlock
- TRVs on most radiators

## 8 ADVICE TO HOUSEHOLDERS

---

Householders must be carefully instructed in how to set and use controls properly and effectively. The operation of programmers in particular can be difficult to understand and householders will receive little or no benefit from an incorrectly set device. They may waste energy.

As a minimum, manufacturers' instructions should be left with the householder, but it will usually be necessary to:

- demonstrate how to set the clock and adjust for GMT and BST
- demonstrate the time control override function
- demonstrate how to set summer hot water only
- demonstrate how to set room and cylinder thermostats
- explain the function of room thermostats and TRVs, eg to be left alone once set, rather than used as on/off switches
- explain that the cylinder thermostat setting should be left at approximately 60°C and that setting it higher than this may give rise to scalding and setting it lower may give rise to the growth of legionella bacteria
- demonstrate how to set TRVs
- explain the need not to adjust radiator lockshield and automatic bypass valves – ie these are set once by the installer
- explain that it is best to switch heating and hot water off when not required
- explain that it is best to turn down the room thermostat to frost protection levels (where a separate frost protection system is not already fitted) – typically around 12°C when homes are unoccupied.

## APPENDIX – DEFINITIONS OF CONTROLS

---

### Automatic bypass valve

A valve to control water flow, operated by the water pressure across it. It is commonly used to maintain a minimum flow rate through a boiler and to limit circulation pressure when alternative water paths are closed (particularly in systems with TRVs).

### Boiler anti-cycling device

A device to introduce a time delay between boiler firing. Any energy saving is due to a reduction in performance of the heating system. The device does not provide boiler interlock.

### Boiler auto ignition

An electrically controlled device to ignite the boiler at the start of each firing, avoiding use of a permanent pilot flame.

### Boiler energy manager

No agreed definition, but typically a device intended to improve boiler control using a selection of features such as weather compensation, load compensation, optimum start control, night setback, frost protection, anti-cycling control and hot water override.

### Boiler interlock

This is not a physical device but an arrangement of the system controls so as to ensure that the boiler does not fire when there is no demand for heat. In a system with a combi boiler it can be achieved by fitting a room thermostat. In a system with a regular boiler it can be achieved by correct wiring interconnections between the room thermostat, cylinder thermostat, and motorised valve(s). It may also be achieved by a suitable boiler energy manager.

### Boiler modulator (air temperature)

A device, or feature within a device, to vary the fuel burning rate of a boiler according to measured room temperature. The boiler under control must have modulating capability and a suitable interface for connection.

### Boiler modulator (water temperature)

A device, or feature within a device, to vary the fuel burning rate of a boiler according to measured water temperature. It is often fitted within the boiler casing. The boiler under control must have modulating capability.

## APPENDIX – DEFINITIONS OF CONTROLS

---

### Boiler thermostat

A thermostat within the boiler casing to limit the temperature of water passing through the boiler by switching off the boiler. The target temperature may either be fixed or set by the user.

### 'CELECT-type' electric heating control

Integrated central control system for electric storage and panel heaters that provides programmed space temperatures at different times of the day for a number of separate heating zones in the dwelling. It minimises the charge period of the storage heaters according to the external temperature.

### Cylinder thermostat

A sensing device to measure the temperature of the hot water cylinder and switch on and off the water heating. A single target temperature may be set by the user.

### Delayed start

A device, or feature within a device, to delay the chosen starting time for space heating according to the temperature measured inside or outside the building.

### Frost thermostat

A device to detect low air temperature and switch on heating to avoid frost damage, arranged to override other controls.

### Load compensator

A device, or feature within a device, which adjusts the temperature of the water circulating through the heating system according to the temperature measured inside the building.

### Motorised valve

A valve to control water flow, operated electrically. A two-port motorised valve controls water flow to a single destination. A three-port motorised valve controls water flow to two destinations (usually for space heating and hot water), and may be either a diverter valve (only one outlet open at a time) or a mid-position valve (either one, or both, outlets open at a time). The valve movement may also open or close switches, which are used to control the boiler and pump.

### Night setback

A feature of a room thermostat that allows a lower temperature to be maintained outside the period during which the normal room temperature is required.

### On/off-peak hot water controller

A control to switch the electrical supply to the main immersion heater from the off-peak electricity supply. It may also include a boost function so that some of the stored water can also be heated using on-peak electricity.

### Optimum start

A device, or feature within a device, to adjust the starting time for space heating according to the temperature measured inside or outside the building, aiming to heat the building to the required temperature by a chosen time.

### Optimum stop

A device, or feature within a device, to adjust the stop time for space heating according to the temperature measured inside (and possibly outside) the building, aiming to prevent the required temperature of the building being maintained beyond a chosen time.

### Pipe thermostat

A switch governed by a sensor measuring pipe temperature, normally used in conjunction with other controls such as a frost thermostat.

### Programmable cylinder thermostat

A combined time switch and cylinder thermostat that allows the user to set different periods with different target temperatures for stored hot water, usually in a daily or weekly cycle.

### Programmable room thermostat

A combined time switch and room thermostat that allows the user to set different periods with different target temperatures for space heating, usually in a daily or weekly cycle.

### Programmer

Two switches operated by a clock to control both space heating and hot water. The user chooses one

APPENDIX – DEFINITIONS OF CONTROLS

---

or more 'on' periods, usually in a daily or weekly cycle. A mini-programmer allows space heating and hot water to be on together, or hot water alone, but not heating alone. A standard programmer uses the same time settings for space heating and hot water. A full programmer allows the time settings for space heating and hot water to be fully independent.

**Pump modulator**

A device to reduce pump power when not needed, determined by hydraulic or temperature conditions or firing status of the boiler.

**Pump over-run**

A timing device to run the heating system pump for a short period after the boiler stops firing to discharge very hot water from the boiler heat exchanger.

**Room thermostat**

A sensing device to measure the air temperature within the building and switch on and off the space heating. A single target temperature may be set by the user.

**Self-adaptive (or self-learning) control**

A characteristic of a device (of various types) that learns from experience by monitoring, and modifies its subsequent behaviour accordingly.

**Temperature and time zone control (or full zone control)**

A control scheme in which it is possible to select different temperatures at different times in two (or more) different zones.

**Time switch**

An electrical switch operated by a clock to control either space heating or hot water, or both together but not independently. The user chooses one or more 'on' periods, usually in a daily or weekly cycle.

**Thermostatic radiator valve**

A radiator valve with an air temperature sensor, used to control the heat output from the radiator by adjusting water flow.

**Weather compensator**

A device, or feature within a device, that adjusts the temperature of the water circulating through the heating system according to the temperature measured outside the building.

**Zone control**

A control scheme in which it is possible to select different times and/or temperatures in two (or more) different zones.

## REFERENCES AND FURTHER INFORMATION

## REFERENCES

- [1] The Building Regulations 1995, Conservation of Fuel and Power, Approved Document L (expected to be superseded by the Building Regulations 2002, Conservation of Fuel and Power, Approved Documents L1 and L2, to be published later in 2001)
- [2] The Building Standards (Scotland) Regulations 1990, Part J, Conservation of Fuel and Power (expected to be superseded by the Building Standards (Scotland) Regulations 2002, Part J, Conservation of Fuel and Power)
- [3] The Building Regulations (N.Ireland) 1999 Technical Booklet F, Conservation of Fuel and Power
- [4] **Energy Efficiency Best Practice programme.** Good Practice Guide 132 'Controls for wet heating systems in small commercial and multi-residential buildings'. EEBPp, London, 2001
- [5] **Energy Efficiency Best Practice programme.** Good Practice Guide 284 'Domestic central heating and hot water'. EEBPp, London, 2000
- [6] Radiomark website: [www.radiomark.org](http://www.radiomark.org)
- [7] **Energy Efficiency Best Practice programme.** General Information Leaflet 83 'Domestic boiler anti-cycling controls – an evaluation'. EEBPp, London, 1997
- [8] **Energy Efficiency Best Practice programme.** General Information Leaflet 59 'Central Heating System Specifications' (CHeSS) – year 2000. EEBPp, London 2001
- [9] SEDBUK database website: [www.boilers.org.uk](http://www.boilers.org.uk)
- [10] European Standard (Telecommunications series) ETSI EN 300 220-1 v1.3.1 (2000-09): Electromagnetic Compatibility and Radio Spectrum Matters (ERM); Short Range Devices (SRD); Radio equipment to be used in the 25 MHz to 1000 MHz frequency range with power levels ranging up to 500 mW; Part 1: Technical characteristics and test methods
- [11] Solid Fuel Association website: [www.solidfuel.co.uk](http://www.solidfuel.co.uk)
- [12] **Chartered Institution of Building Services Engineers.** TM13:2000 'Minimising the risk of Legionnaires' Disease'. CIBSE, London, 2000
- [13] Health and Safety Executive. L8: 'The prevention or control of legionellosis'. HSE Books, Suffolk, 2000

## FURTHER INFORMATION

A website with individual boiler efficiencies, including SEDBUK figures, is maintained at: [www.boilers.org.uk](http://www.boilers.org.uk)

The Government's Energy Efficiency Best Practice programme provides impartial, authoritative information on energy efficiency techniques and technologies in industry and buildings. This information is disseminated through publications, videos and software, together with seminars, workshops and other events. Publications within the Best Practice programme are shown opposite.

Visit the website at [www.energy-efficiency.gov.uk](http://www.energy-efficiency.gov.uk)  
Call the Environment and Energy Helpline on **0800 585794**

## For further specific information on:

Buildings-related projects contact:  
Enquiries Bureau

## BRECSU

BRE  
Garston, Watford WD25 9XX  
Tel 01923 664258  
Fax 01923 664787  
E-mail [brecsuenq@bre.co.uk](mailto:brecsuenq@bre.co.uk)

Industrial projects contact:  
Energy Efficiency Enquiries Bureau

## ETSU

Harwell, Oxfordshire  
OX11 0RA  
Tel 01235 436747  
Fax 01235 433066  
E-mail [etsuenq@aeat.co.uk](mailto:etsuenq@aeat.co.uk)

**Energy Consumption Guides:** compare energy use in specific processes, operations, plant and building types.

**Good Practice:** promotes proven energy-efficient techniques through Guides and Case Studies.

**New Practice:** monitors first commercial applications of new energy efficiency measures.

**Future Practice:** reports on joint R&D ventures into new energy efficiency measures.

**General Information:** describes concepts and approaches yet to be fully established as good practice.

**Fuel Efficiency Booklets:** give detailed information on specific technologies and techniques.

**Introduction to Energy Efficiency:** helps new energy managers understand the use and costs of heating, lighting, etc.